

**TD-29 AC/DC
FSK-modem**

INSTALLATIONSANVISNING INSTALLATION MANUAL INSTALLATIONS ANLEITUNG MANUEL D'INSTALLATION

6611-2001

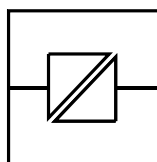

Galvanic
Isolation

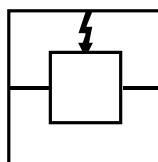

Transient
Protection

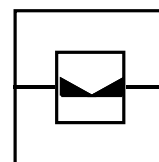

Balanced
Transmission

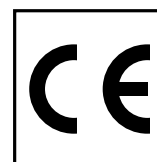

CE
Approved

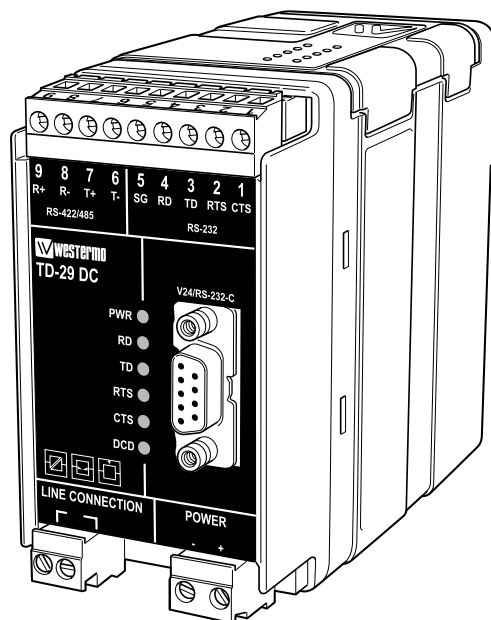

***Multidropp 2-tråd
Multidrop 2-wire
Multidrop 2-Draht
Multipoints 2-fils***

 **westermo**[®]

www.westermo.com

[®]
WESTERMO

Innehållsförteckning

1. Säkerhet	3
2. Godkännanden	3
2.1 Tillverkningsdeklaration (Declaration of conformity)	4
3. Introduktion	5
4. Specifikationer	6–7
4.1 Anslutningar	6
4.2 Isolation mellan gränssnitten	6
4.3 Temperaturområde	6
4.4 Mekanik	7
4.5 Räckvidd och signaldämpning	7
4.6 Vändtider	7
5. Underhåll	8
6. Installation	8–12
6.1 Montering/Demontering	8
6.2 Anslutningar	9
6.3 Lysdiodsindikeringar	9
6.4 Gränssnitt 1 (RS-232)	10
6.5 Gränssnitt 2 (RS-422/485)	10
6.6 Gränssnitt 3	10
6.7 Matning DC anslutning	10
6.8 Matning AC anslutning	10
6.9 Inställning	11–12
6.9.1 Switchinställningar	11–12
7. Funktionell beskrivning	13–14
7.1 Blockdiagram	13
7.2 RS-422/485 anslutning	13
7.3 Linjeanslutning	14

1. Säkerhet



Allmänt:

Innan enheten används, läs denna manual fullständigt och jämför med uppgifter på enheten, samt säkerställ att du har förstått all information. Kontrollera att användandet av enheten i din installation inte kommer att överskrida specificerade säkerhetsprestanda för enheten.



Före installations-, underhålls- eller modifieringsarbete:

Potentialutjämna dig till en jordnings punkt (tex. genom att använda handledsband), så att skada av intern elektronik på grund av elektrostatiska urladdningar (ESD) förhindras.

Koppla ifrån enheten från AC/DC matningsnät samt alla andra elektriska anslutningar, så att åtkomst till farliga spänningar förhindras.



Installation:

Enheten är konstruerad för användning i professionella system. Enheten skall installeras i utrymmen med begränsad åtkomst, t ex låsbart skåp med tillträde endast för service personal.

Enheten är konstruerad för fast anslutning till AC/DC matningsnät och skall installeras av behörig personal.

Enhetens anslutning till matningsnätet skall vara tillräckligt avsäkrat, och om så krävs skall det vara möjligt att manuellt koppla från enheten från matningsnätet. Observera att nationella installations regler skall följas.

Enhet med märkspänning överskridande 42,4 V topp eller 60 V DC, är en klass I utrustning som skall skyddsjordas.

Enhet med märkspänning upp till 42,4 V topp eller 60 V DC, är en klass III utrustning som skall vara separerad från farliga spänningar med dubbel eller förstärkt isolation.

Enheten kyls genom konvektion. Följ föreskrivna monterings rekommendationer för att förhindra störningar i kylande luftström kring enheten (se Installation).

TD-29 är avsedd att användas på dedikerade linjer och får ej kopplas in på allmänna eller hyrda telelinjer. Ej kodkänd enligt Europeisk standard CTR-15.

2. Godkännanden

Uppfyllande av direktiv 73/23/EEC (lågspännings direktivet) har säkerställt genom tillämpning av standard EN60950.

Uppfyllande av direktiv 89/339/EEC (elektromagnetisk kompatibilitet) har säkerställts genom tillämpning av standard EN61000-6-2 (immunitet i industrimiljö) och standard EN61000-6-3 (emission från utrustning i bostäder, kontor och liknande miljö).

2.1 Tillverkningsdeklaration (Declaration of conformity)



Westermo Teleindustri AB

Declaration of conformity

The manufacturer Westermo Teleindustri AB
SE-640 40 Stora Sundby, Sweden

Herewith declares that the product(s)

Type of product	Model	Art no	Installation manual
DIN-rail	TD-29 AC	3611-0101,0104,0110	6611-2001
DIN-rail	TD-29 DC	3611-0001,0003,0004	6611-2001
DIN-rail	TD-29P	3611-0020	6611-2021

is in conformity with the following EC directive(s).

No	Short name
89/336/EEG	Electromagnetic Compatibility (EMC)
73/23/EEG	Low Voltage Directive - LVD

References of standards applied for this EC declaration of conformity.

No	Title	Issue
EN 61000-6-2	Immunity for industrial environments	2 (2001)
EN 55024	Information technology equipment ñ Immunity	1 (1998)
EN 61000-6-3	Emission standard for residential, commercial and light-industrial environments	1 (2001)
EN 60950	Safety of information technology equipment	6 (2000)

The last two digits of the year in which the CE marking was affixed: 03

Herewith declares that product(s) listed above is in conformity with

No	Title	Issue
FCC part 15	Radio frequency devices	

Hans Levin
Technical Manager
9th October 2003

Postadress/Postal address
S-640 40 Stora Sundby
Sweden

Tel.
016-428000
Int+46 16428000

Telefax
016-428001
Int+46 16428001

Postgiro
52 72 79-4

Bankgiro
5671-5550

Org.nr/
Corp. identity number
556361-2604

Registered office
Eskilstuna

3. Introduktion

TD-29 är konstruerad för kommunikation på 2-tråds partvinnad kopparkabel. Multidropp och punkt till punkt förbindelser med halvduplex är möjliga. TD-29 klarar halv duplex med 19.2 kbit/s som maximal överföringshastighet.

TD-29 kan ställas in för att passa olika driftsförhållanden med hjälp av omkopplare.

Såväl antal databitar som sändar- och mottagarnivåer samt olika kommunikationsgränssitt kan väljas. Utrustningar kan anslutas via 9-polig D-sub alternativt skruvplint (RS-232) eller skruvplint (RS-422/485). Fyra alternativa överföringshastigheter finns.

När modemmet är anslutet via RS-232 gränssnittet kan kommunikationsriktningen kontrolleras med eller utan hårdvaruhandskakning (RTS).

Vid multidroppförbindelser är räckvidden beroende av hur många enheter som är anslutna till bussen. (Se kapitel 4.5)

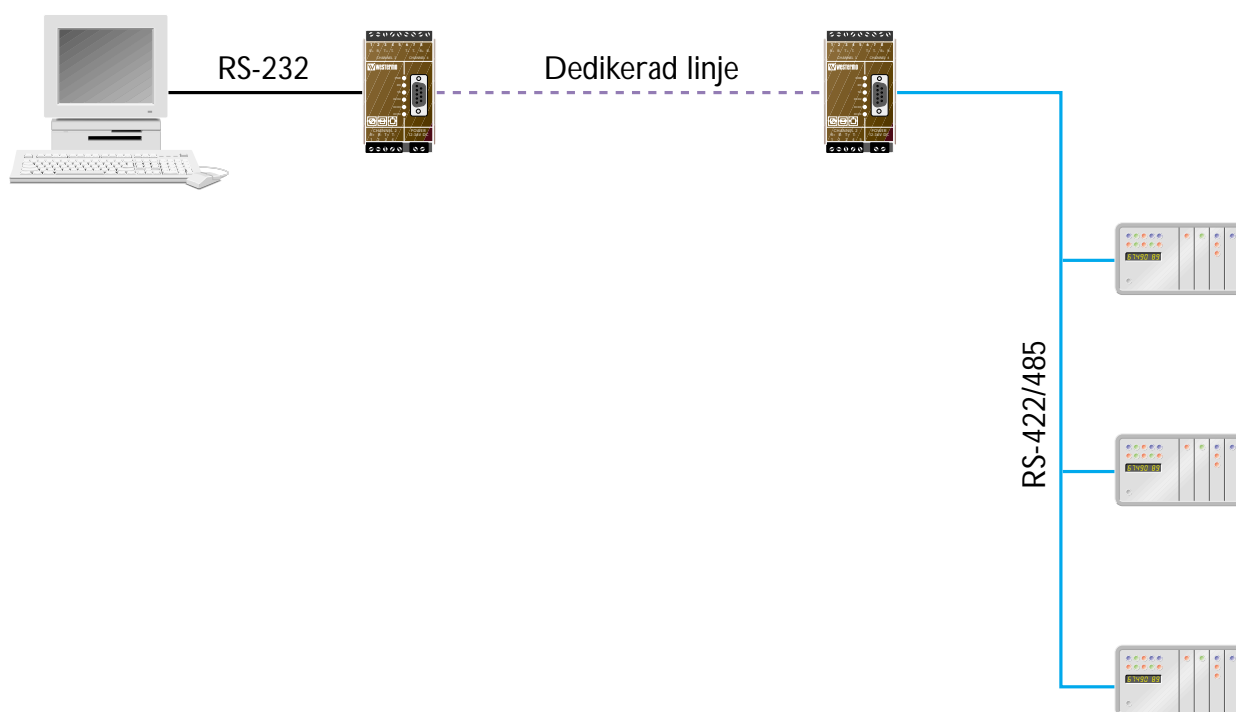

4. Specifikationer

4.1 Anslutningar

Matning

	TD-29 AC	TD-29 DC	TD-29 36–55 VDC
Märkspänning	115 V/230 VAC	24 VDC	48 VDC
Arbetspänning	104–132/207–264 VAC	12–36 VDC	36–55 VDC
Märkström	24 mA/12mA	200 mA	50 mA
Märkfrekvens	48–62 Hz	–	–
Anslutning	3-polig skruvplint	2-polig skruvplint	2-polig skruvplint
Anslutningsbar area	0,2–2,5 mm ² (AWG 24-12)		

RS-422/485

Elektrisk specifikation	RS-422/485
Datahastighet	2 400–19.2 kbit/s
Anslutning	5-polig skruvplint
Anslutningsarea	0,2–2,5 mm ² (AWG 24-12)
Kretstyp	TNV-1, partvinnade ledare, ej krav på skärm

RS-232

Elektrisk specifikation	RS-232
Datahastighet	2 400 bit/s–19.2 kbit/s
Anslutning	9 polig D-sub, DCE
Kretstyp	SELV, max 15 m längd, ej krav på skärm

FSK-linje

Elektrisk specifikation	–
Datahastighet	2 400 bit/s–19.2 kbit/s
Anslutning	2 polig skruvplint
Anslutningsarea	0,2–2,5 mm ² (AWG 24-12)
Kretstyp	TNV-3

4.2 Isolation mellan gränssnitten

Matning till övriga	AC: 3 kV RMS @ 50 Hz och 60s varaktighet DC: 1 kV RMS @ 50 Hz och 60s varaktighet
FSK-linje till övriga	1,5 kV RMS @ 50 Hz och 60s varaktighet

4.3 Temperaturområde

Temperatur, drift	5–50°C
Temperatur, lagring och transport	–40 till +85°C
Relativ fuktighet, drift	0 till 95% (icke kondenserande)
Relativ fuktighet, lagring och transport	0 till 95% (kondensation utanför förpackning tillåten)

4.4 Mekanik

Dimension (B x H x D)	55 x 100 x 128 mm
Vikt	0,5 kg
Montering	35 mm DIN skena
Skyddsklass, mot åtkomst	IP 20 (IEC 529)

4.5 Räckvidd och signaldämpning

Överförings- hastighet (bit/s)	Räckvidd- punkt till punkt (km)	Dämpning (dB/km)	Dämpning hastighet per ansluten enhet (multidropp) (dB)
2 400	16	1,5	0,2
4 800	14	1,7	0,2
9 600	11	2,1	0,3
19 200	9	2,5	0,4

Uppmätt på Cat. 5 kabel UTP 4x2x24AWG. Signalnivå > –24 dBm. Räckvidden är beroende av linjens kvalitet.

4.6 Vändtider

RS-485

Hastighet bit/s	Vändtid μ s
2 400	800
4 800	400
9 600	320
19 200	300

5. Underhåll

Inget krav på underhåll, så länge enheten används på avsett sätt inom specificerade förutsättningar.

6. Installation

6.1 Montering/Demontering

Före montering eller demontering av enheten:

Potentialutjämna dig till en jordnings punkt (tex. genom att använda handledsband), så att skada av intern elektronik på grund av elektrostatiska urladdningar (ESD) förhindras.

Koppla ifrån enheten från AC/DC matningsnät samt alla andra elektriska anslutningar, så att åtkomst till farliga spänningar förhindras.

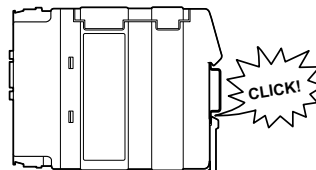
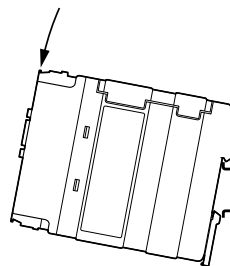

Montering

Enhetsen är avsedd att monteras på en 35 mm DIN skena vilken skall vara horisontellt fastsatt, tex. på en vägg eller montageplåt i skåp.

Enhetsen kyls genom konvektion. För att förhindra störningar i kylande luftström kring enhetsen krävs ett fritt utrymme på 25 mm ovan/nedan och 10 mm till vänster/höger om enhetsen.

Snäppfastsättning utan verktyg, se figur.

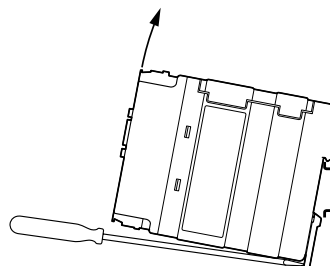
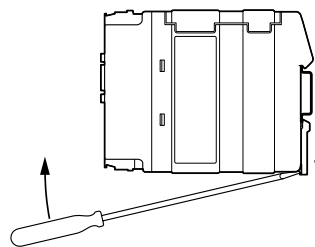
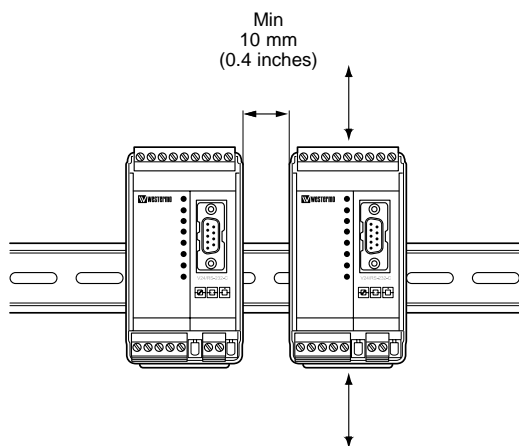

Demontering

Pressa ner den svarta hållaren på enhetsens nedre del med hjälp av en skruvmejsel, se figur.

6.2 Anslutningar

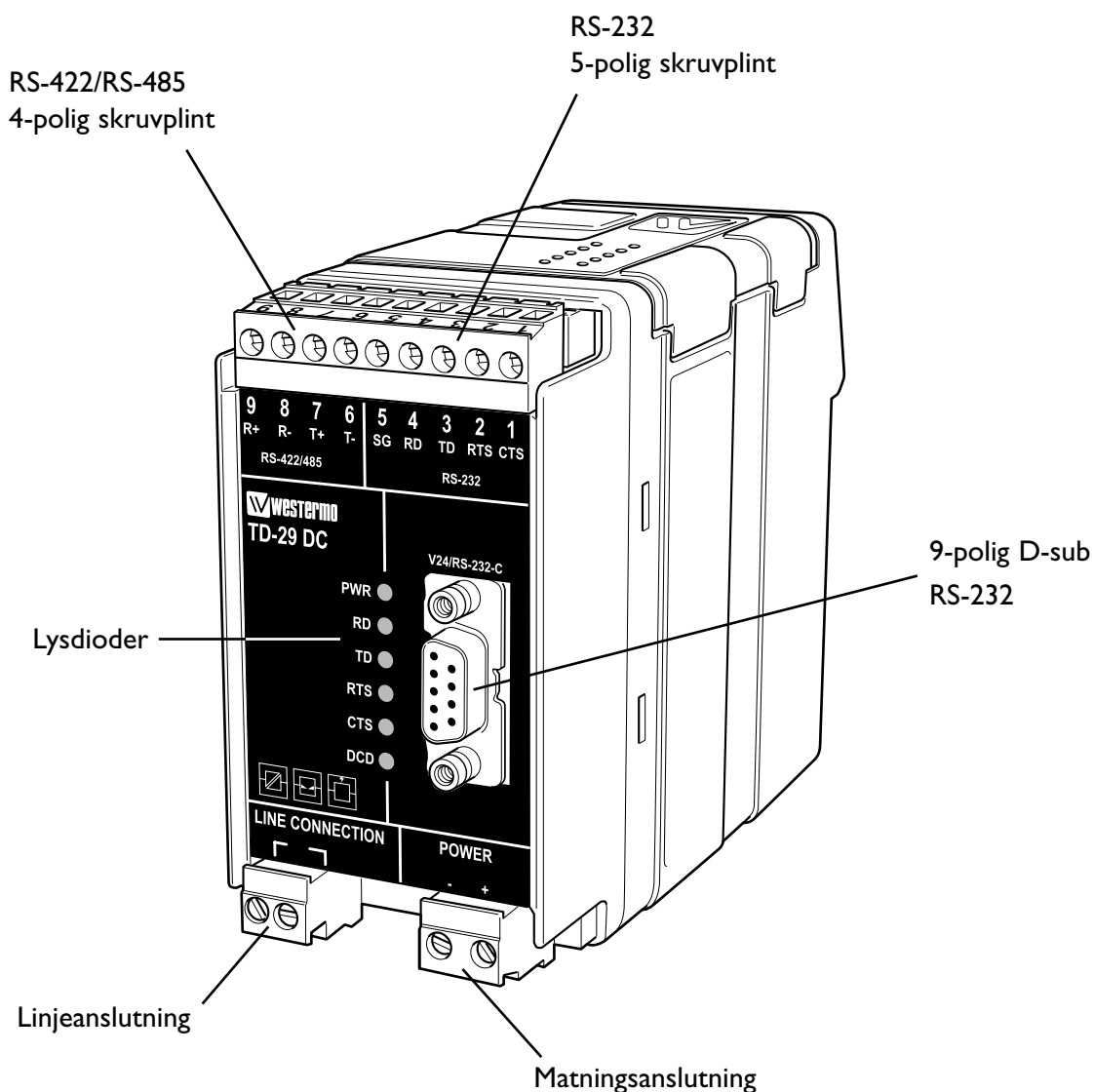

6.3 Lysdiodsindikeringar

PWR	LED till LED från	Matningsspänning korrekt Ingen matningsspänning
RD	LED till LED från	Mottagen linjedata Ingen mottagen data
TD	LED till LED från	Sänd linjedata Ingen sänddata
RTS	LED till LED från	RTS från inkopplad utrustning Ingen RTS från inkopplad utrustning
DCD	LED till LED från	DCD aktiv DCD inaktiv
CTS	LED till LED från	CTS signal aktiv CTS signal inaktiv

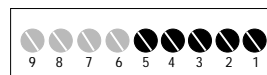
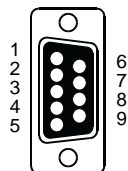

6.4 Gränssnitt 1 (RS-232)

9-polig D-sub Ansl. nr.	9-polig Skruvplint	Riktning	Beskrivning
1	–	–	–
2	4	ut	RD/Received Data
3	3	in	TD/Transmitted Data
4	–	–	–
5	5	–	SG/Signal Ground
6	–	ut	DSR/Data Set Ready
7	2	in	RTS/Request to Send
8	1	ut	CTS/Clear to Send
9	–	–	–

6.5 Gränssnitt RS-422/485

9-polig Skruvplint	Riktning	ITU-TV.11 Benämning	Beskrivning
9	in	A' (R+)	RS-422 Mottagare
8	ut	B' (R-)	RS-422 Mottagare
7	in/ut	A (T+)	RS-422/485 Sändare/mottagare
6	in/ut	B (T-)	RS-422/485 Sändare/mottagare

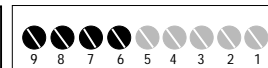

Definitionen R+/R-, T+T- kan variera mellan olika tillverkare.

6.6 Linjegränssnitt

2-polig skruvplint	Riktning	Beskrivning
1	in/ut	Sändare/mottagare
2	in/ut	(2-tråd)



6.7 Matning DC anslutning

Anslutning	Benämning	Beskrivning
1	–	0V DC
2	+	12–55VDC



6.8 Matning AC anslutning

Benämning	Beskrivning
L	115*/230 VAC
N	115*/230 VAC
	PE/skyddsjord



* Specialversion 115 VAC

6.9 Inställning



6.9.1 Switchinställningar

DIP-switchar är tillgängliga under locket på toppen av modemet. DIP-switcharna används för att konfigurera enheten.



Varning!

Potentialutjämna dig till en jordnings punkt (tex. genom att använda handledsband), så att skada av intern elektronik på grund av elektrostatiska urladdningar (ESD) förhindras, innan locket på modemets topp tas av.



Varning! Öppna ej ansluten enhet.

Koppla ifrån enheten från AC/DC matningsnät samt alla andra elektriska anslutningar, så att åtkomst till farliga spänningar förhindras.

OBS

Vid inställning med hjälp av DIP-switchar kommer utförd inställning att gälla efter tillslag av AC/DC matning. Om det under drift sker inställning med någon annan metod, åsidosätts DIP-switch inställningen. Efter förnyat tillslag av AC/DC matning så har dock DIP-switch inställningen företräde framför utförd inställning med någon annan metod.

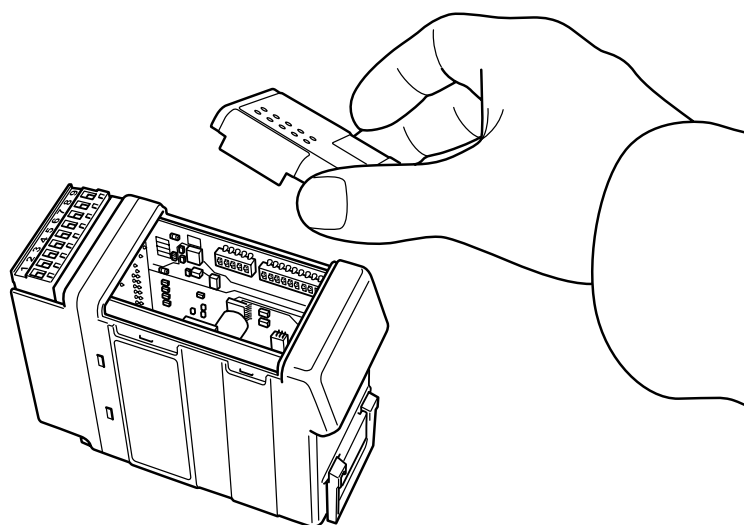

Switchblock 1 – S1

Val av antal databitar

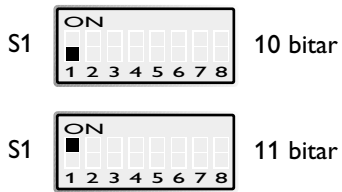

Val av Bärvägsaktivering

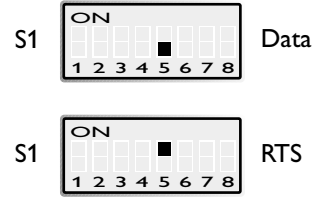

Val av överföringshastighet

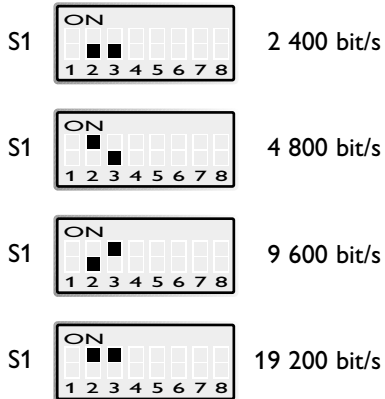

Val av uteffekt*

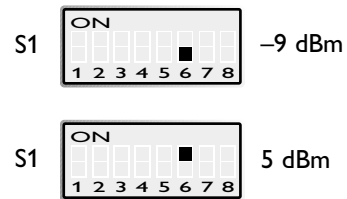

* Belastning 600 Ω

Linjeterminering*

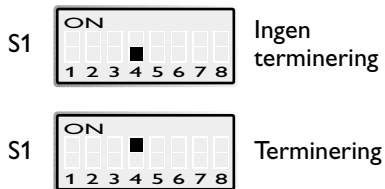

Val av nivå för DCD avkänning

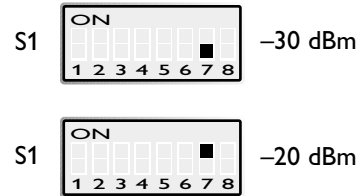

* Terminering av enheten i linjens ändrar

S1: 8 används ej

Switchblock 2 – S2

Terminering av RS-422*

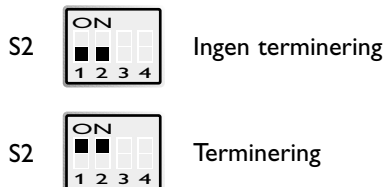

Terminering av RS-485*

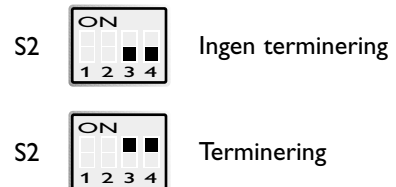

* Terminering av enheten i linjens ändrar

* Terminering av enheten i linjens ändrar

Fabriksinställning



7. Funktionell beskrivning

7.1 Blockdiagram

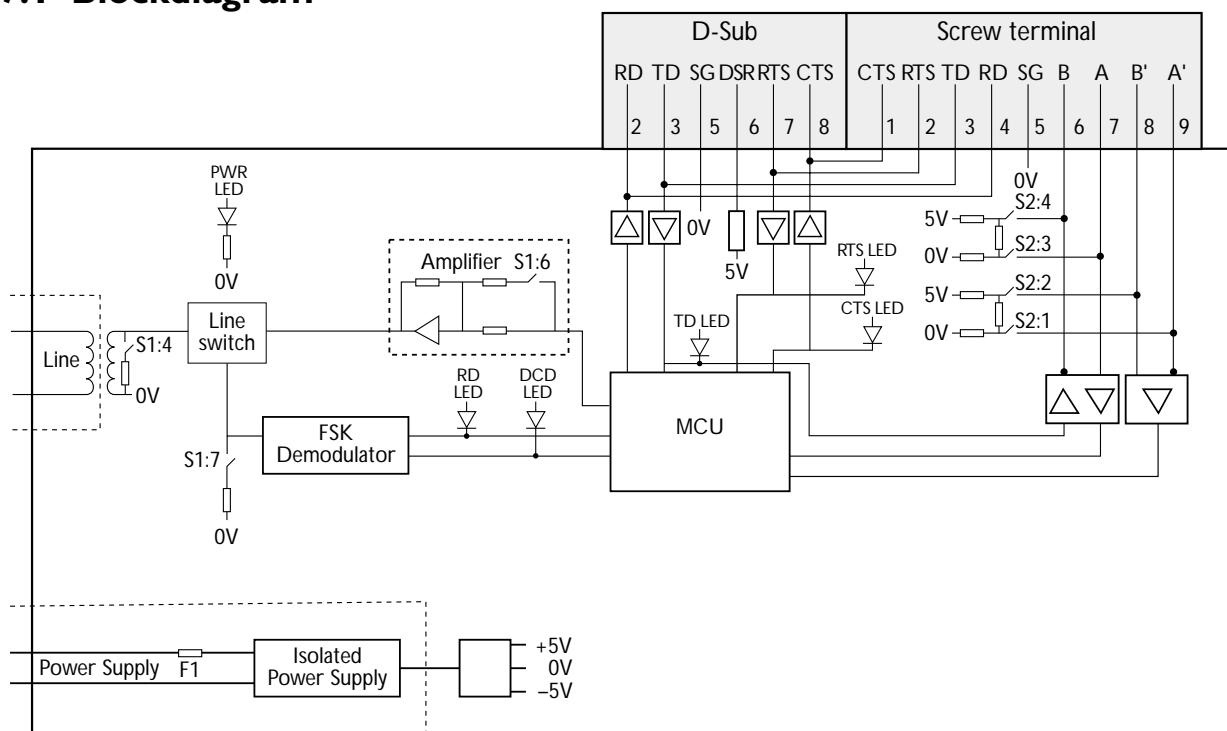

7.2 RS-422/485 anslutning

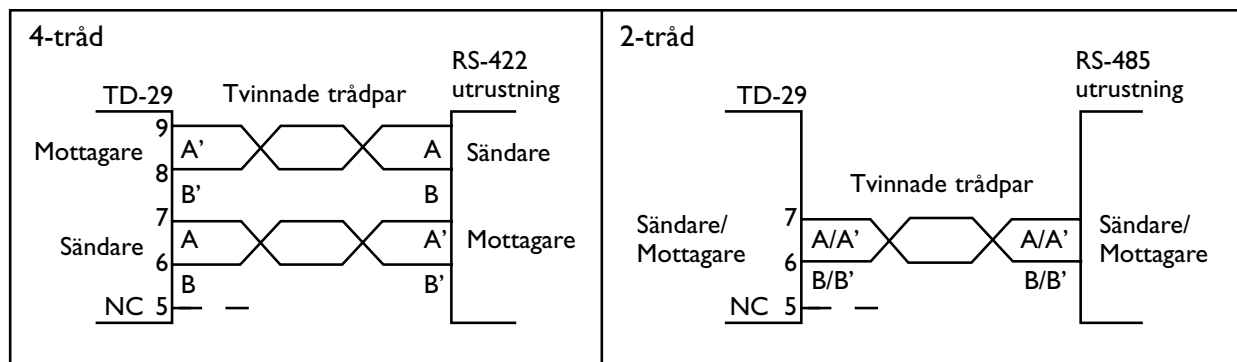

7.3 Linjeanslutning

2-polig
frånskiljbar skruvplint

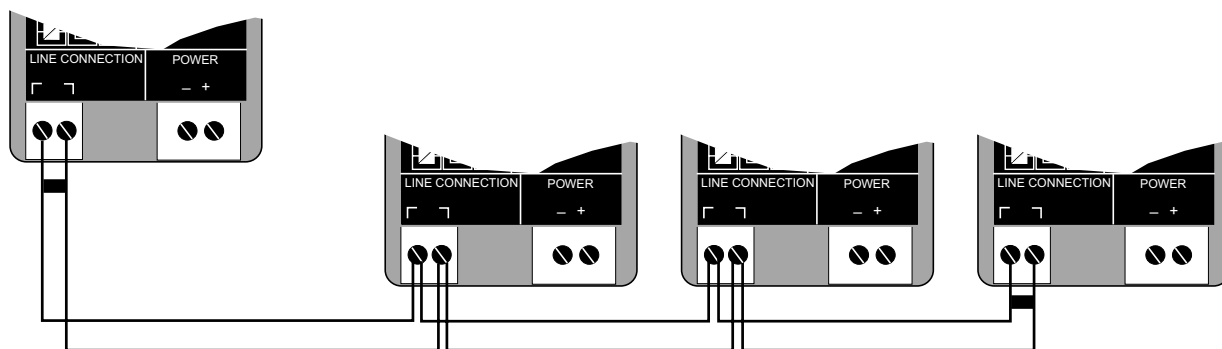

Multidropp halv duplex med TD-29

- Terminering görs med DIP-switchar

Contents

1. Safety	17
2. Approvals	17
2.1 Declaration of conformity	18
3. Introduction	19
4. Specifications	20–21
4.1 Connections	20
4.2 Isolation between interfaces	20
4.3 Environmental	20
4.4 Mechanical	21
4.5 Maximum range and signal loss.....	21
4.6 Turning time	21
5. Maintenance	22
6. Installation	22–24
6.1 Mounting/Removal	22
6.2 Connections	23
6.3 LED Status Indicators	23
6.4 Interface 1 (RS-232)	24
6.5 Interface 2 (RS-422/485)	24
6.6 Interface 3	24
6.7 Power connection DC	24
6.8 Power connection AC	24
6.9 Configuration	25–26
6.9.1 DIP switch settings	25
7. Functional description	27–28
7.1 Block diagram	27
7.2 RS-422/485 connection	27
7.3 Line connection	28

1. Safety



General:

Before using this unit, read this manual completely and gather all information on the unit. Make sure that you understand it fully. Check that your application does not exceed the safe operating specifications for this unit.



Before installation, maintenance or modification work:

Prevent damage to internal electronics from electrostatic discharges (ESD) by discharging your body to a grounding point (e.g. use of wrist strap).
Prevent access to hazardous voltages by disconnecting the unit from AC/DC mains supply and all other electrical connections.



Installation:

This unit should only be installed by qualified personnel.

This unit should only be installed in a “restricted access area”, for example a lockable cabinet where access is restricted to service personnel only.

This unit is intended for permanent connection to the AC/DC mains supply.

The power supply wiring must be sufficiently fused, and if necessary it must be possible to disconnect manually from the AC/DC mains supply. Ensure compliance to national installation regulations.

Units with the rated voltage exceeding 42.4 V peak or 60 VDC, are defined as class I equipment with a protective earthing conductor terminal.

Units with the rated voltage up to 42.4 V peak or 60 VDC, are defined as class III equipment and shall be separated from hazardous voltage by double or reinforced insulation.

This unit uses convection cooling. To avoid obstructing the air flow around the unit, follow the spacing recommendations (see Installation section).

The TD-29 is designed to be used on dedicated lines and is not approved to European standard CTR-15 (2-wire leased line).

2. Approvals

Conformity with the Directive 73/23/EEC (Low Voltage Directive) has been assessed by application of the standard EN 60950.

Conformity with the Directive 89/339/EEC (Electromagnetic compatibility) has been assessed by application of standards EN 61000-6-2 (industrial immunity) and EN 61000-6-3 (residential emission).

2.1 Declaration of Conformity



Westermo Teleindustri AB

Declaration of conformity

The manufacturer Westermo Teleindustri AB
SE-640 40 Stora Sundby, Sweden

Herewith declares that the product(s)

Type of product	Model	Art no	Installation manual
DIN-rail	TD-29 AC	3611-0101,0104,0110	6611-2001
DIN-rail	TD-29 DC	3611-0001,0003,0004	6611-2001
DIN-rail	TD-29P	3611-0020	6611-2021

is in conformity with the following EC directive(s).

No	Short name
89/336/EEG	Electromagnetic Compatibility (EMC)
73/23/EEG	Low Voltage Directive - LVD

References of standards applied for this EC declaration of conformity.

No	Title	Issue
EN 61000-6-2	Immunity for industrial environments	2 (2001)
EN 55024	Information technology equipment ñ Immunity	1 (1998)
EN 61000-6-3	Emission standard for residential, commercial and light-industrial environments	1 (2001)
EN 60950	Safety of information technology equipment	6 (2000)

The last two digits of the year in which the CE marking was affixed: 03

Herewith declares that product(s) listed above is in conformity with

No	Title	Issue
FCC part 15	Radio frequency devices	

Hans Levin
Technical Manager
9th October 2003

Postadress/Postal address
S-640 40 Stora Sundby
Sweden

Tel.
016-428000
Int+46 16428000

Telefax
016-428001
Int+46 16428001

Postgiro
52 72 79-4

Bankgiro
5671-5550

Org.nr/
Corp. identity number
556361-2604

Registered office
Eskilstuna

3. Introduction

The TD-29 is designed for communication on 2-wire copper cable (twisted pair). Multidrop or point to point is possible. The TD-29 will support half duplex at baud rates up to 19.2 kbit/s.

The TD-29 is easy to configure for different operating conditions with DIP-switches. Character formats, baud rate, transmission level, DCD detection level and communication interface are selectable. DTE-equipment can be connected through an RS-232 or an RS-422/485 interface. The RS-232 connection can be made through either the DB-9 connector or screw terminal on the front of the unit. There are four baud rate settings.

When using the RS-232 interface the direction of communication can be controlled by RTS handshake signal or incoming data.

When connecting in multidrop configuration the maximum bus length depends on the number of units connected. (see chapter 4.5)

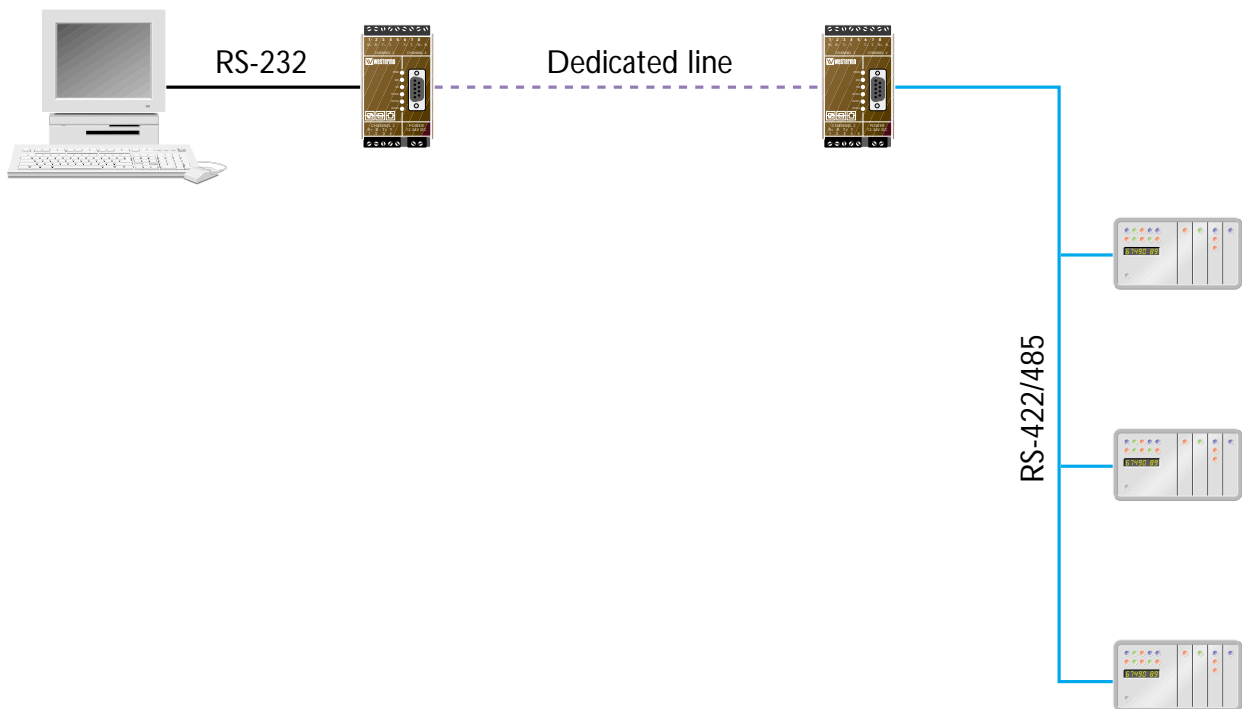

4. Specifications

4.1 Connections

Power

	TD-29 AC	TD-29 DC	TD-29 36–55 VDC
Rated voltage	115 V/230 VAC	24 VDC	48 VDC
Operating voltage	104–132/207–264 VAC	12–36 VDC	36–55 VDC
Rated current	24 mA/12mA	200 mA	50 mA
Rated frequency	48–62 Hz	–	–
Connection	3-pos. screw terminal	2-pos. screw term.	2-pos. screw term.
Connector size	0.2–2.5 mm ² (AWG 24-12)		

RS-422/485

Electrical specification	RS-422/485
Data rate	2 400 bit/s–19.2 kbit/s
Connection	5-position screw terminal
Connector size	0.2–2.5 mm ² (AWG 24-12)
Circuit type	TNV-1, twisted pair, shielding not required

RS-232

Electrical specification	RS-232
Data rate	2 400 bit/s–19.2 kbit/s
Connection	9 position D-sub, DCE
Circuit type	SELV, max 15 m length, shielding not required

Line interface

Electrical specification	–
Data rate	2 400 bit/s–19.2 kbit/s
Connection	2 position screw terminal
Connector size	0,2–2,5 mm ² (AWG 24-12)
Circuit type	TNV-3

4.2 Isolation between interfaces

Power to all other	AC: 3 kV RMS @ 50 Hz and 60s duration DC: 1 kV RMS @ 50 Hz and 60s duration
FSK-Line to all other	1.5 kV RMS @ 50 Hz and 60s duration

4.3 Environmental

Temperature, operating	5–50°C
Temperature, storage and transportation	–40 to +85°C
Relative humidity, operating	0 to 95% (non-condensing)
Relative humidity, storage and transportation	0 to 95% (condensation allowed outside packaging)

4.4 Mechanical

Dimension (W x H x D)	55 x 100 x 128 mm
Weight	0.5 kg
Mounting	35 mm DIN-rail
Degree of protection	IP 20 (IEC 529)

4.5 Maximum range and signal loss

Transmission speed (bit/s)	Range point to point (km)	Signal loss (dB/km)	Loss per unit (multidrop) (dB)
2 400	16	1.5	0.2
4 800	14	1.7	0.2
9 600	11	2.1	0.3
19 200	9	2.5	0.4

Measured with Cat. 5 cable UTP 4x2x24AWG. Signal level >–24 dBm. The bus length depends on the line quality.

4.6 Turning time

RS-485

Data rate bit/s	Turning time μ s
2 400	800
4 800	400
9 600	320
19 200	300

5. Maintenance

No maintenance is required, as long as the unit is used as intended within the specified conditions.

6. Installation

6.1 Mounting / Removal

Before mounting or removing the unit:

Prevent damage to internal electronics from electrostatic discharges (ESD) by discharging your body to a grounding point (e.g. use of wrist strap).

Prevent access to hazardous voltages by disconnecting the unit from AC/DC power supply and all other electrical connections.

Mounting

This unit should be mounted on 35 mm DIN-rail which is horizontally mounted on a wall or cabinet backplate.

This unit uses convection cooling. To avoid obstructions to the airflow around the unit, use the following spacing rules. Recommended spacing 25 mm (1.0 inch) above/below and 10 mm (0.4 inches) left/right the unit.

Snap on mounting, see figure

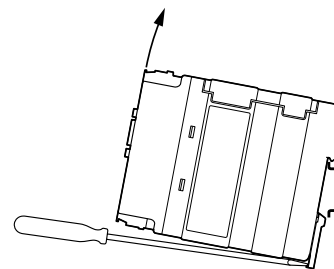
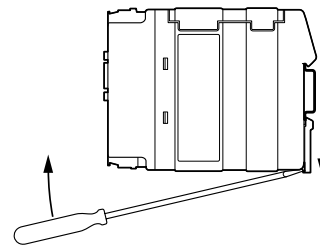
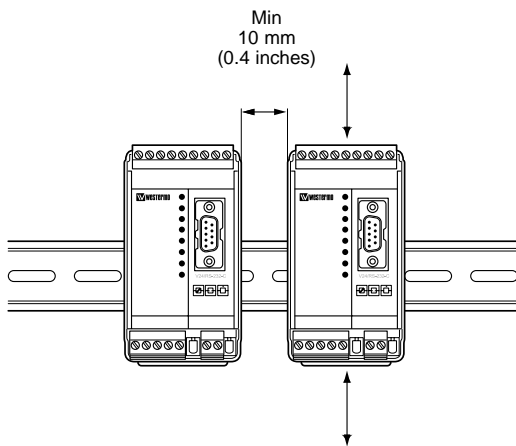
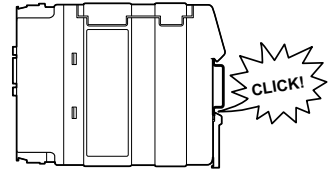
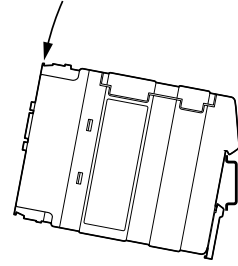

Removal

Press down the black support at the back of the unit using a screwdriver, see figure.

6.2 Connections

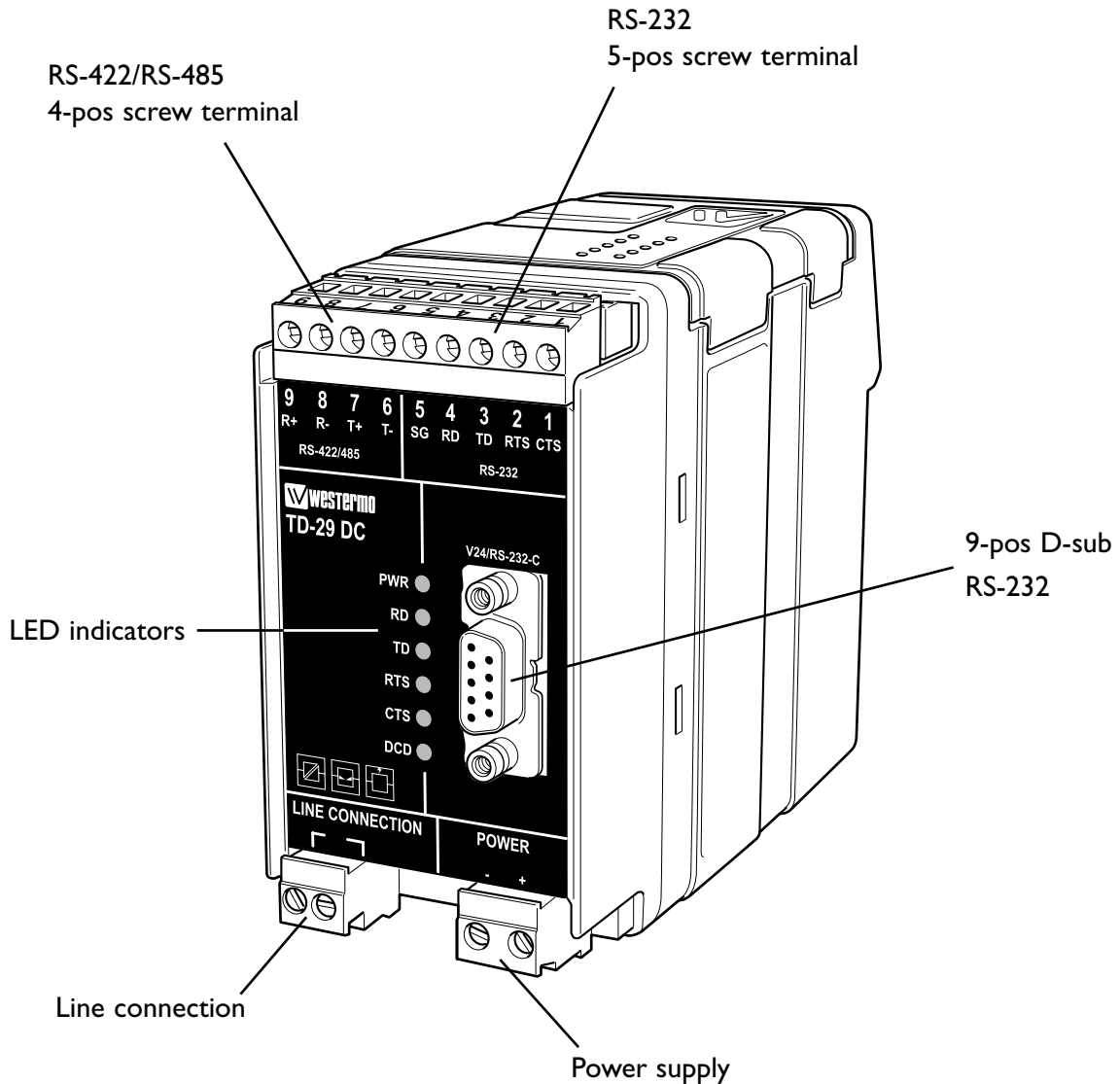

6.3 LED Status Indicators

PWR	LED on LED off	Power on Power off
RD	LED on LED off	Receive Line Data active Receive Line Data inactive
TD	LED on LED off	Transmit Line Data active Transmit Line Data inactive
RTS	LED on LED off	Request To Send active Request To Send inactive
DCD	LED on LED off	Data Carrier Detect active Data Carrier Detect inactive
CTS	LED on LED off	Clear To Send active Clear To Send inactive

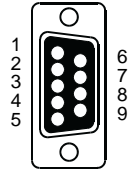

6.4 Interface 1 (RS-232)

9-pos. D-sub Pin. no.	9-pos. Screw terminal	Direction	Description
1	–	–	–
2	4	out	RD/Received Data
3	3	in	TD/Transmitted Data
4	–	–	–
5	5	–	SG/Signal Ground
6	–	out	DSR/Data Set Ready
7	2	in	RTS/Request to Send
8	1	out	CTS/Clear to Send
9	–	–	–

6.5 Interface RS-422/485

9-pos. Screw terminal	Direction	ITU-T V.11 Description	Description
9	in	A' (R+)	RS-422 Receiver
8	out	B' (R-)	RS-422 Receiver
7	in/out	A (T+)	RS-422/485 Transmitter/Receiver
6	in/out	B (T-)	RS-422/485 Transmitter/Receiver

The definition of R+/R-, T+T- can vary between different manufacturers.

6.6 Line interface

2-pos. screw terminal	Direction	Description
1	in/out	Transmitter/Receiver (2-wire)
2	in/out	



6.7 Power connection DC

Screw no.	Description	Power supply
1	–	0 V DC
2	+	12–55 V DC



6.8 Power connection AC

Screw no.	Power supply
L	115*/230 V AC
N	115*/230 V AC
	PE/Protective Earth

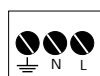

* Special version 115 VAC

6.9 Configuration

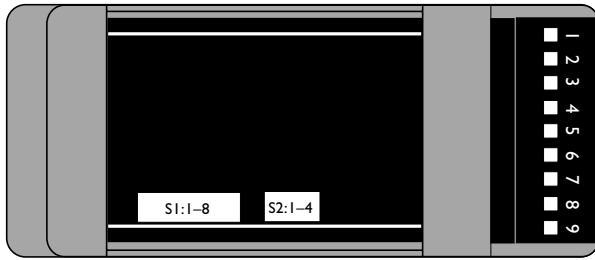

6.9.1 DIP switch settings

DIP-switches are accessible under the lid on top of the unit. DIP-switches are used to configure the modem.



Warning!

Prevent damage to internal electronics from electrostatic discharges (ESD) by discharging your body to a grounding point (e.g. use of wrist strap), before the lid on top of the modem is removed.



Warning! Do not open connected equipment.

Prevent access to hazardous voltages by disconnecting the unit from AC/DC power supply and all other electrical connections.

NOTE

When configuring via DIP-switches, the settings of DIP-switches configure the unit only after a power reset. A setting configured by any other method during normal operation, overrides the DIP-switch setting. However, at power up, the DIP-switch settings have precedence over the setting configured by any other method.

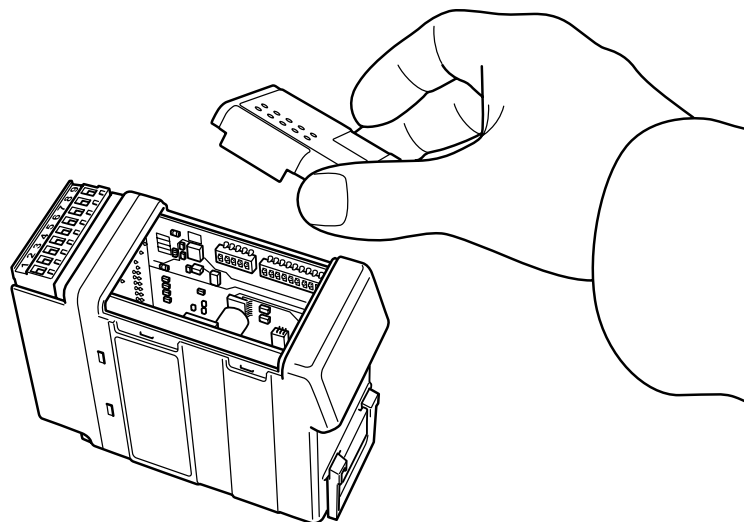

Switch block 1 – S1

Character format

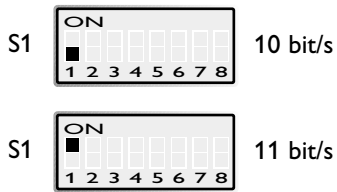

Carrier active using RTS or incoming data

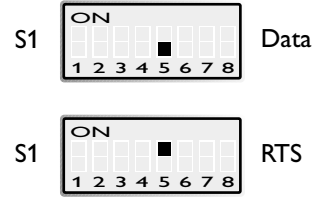

Selection of Baud rate

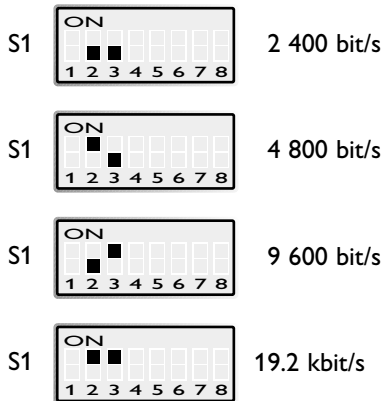

Selection of transmission level*

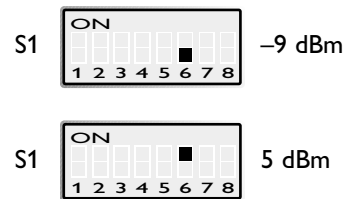

* Load 600 Ω

Termination of the line*

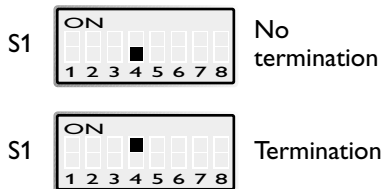

* The line should be terminated at the end points.

Selection of minimum detection level

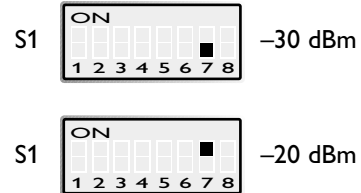

S1: 8 not used

Switch block 2 – S2

Termination of RS-422*

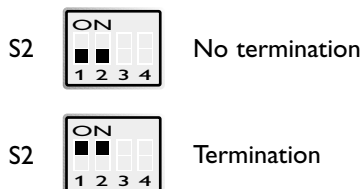

* The line should be terminated at the end points.

Termination of RS-485*

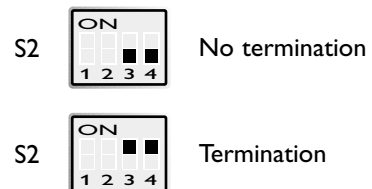

* The line should be terminated at the end points.

Factory setting



7. Functional description

7.1 Block diagram

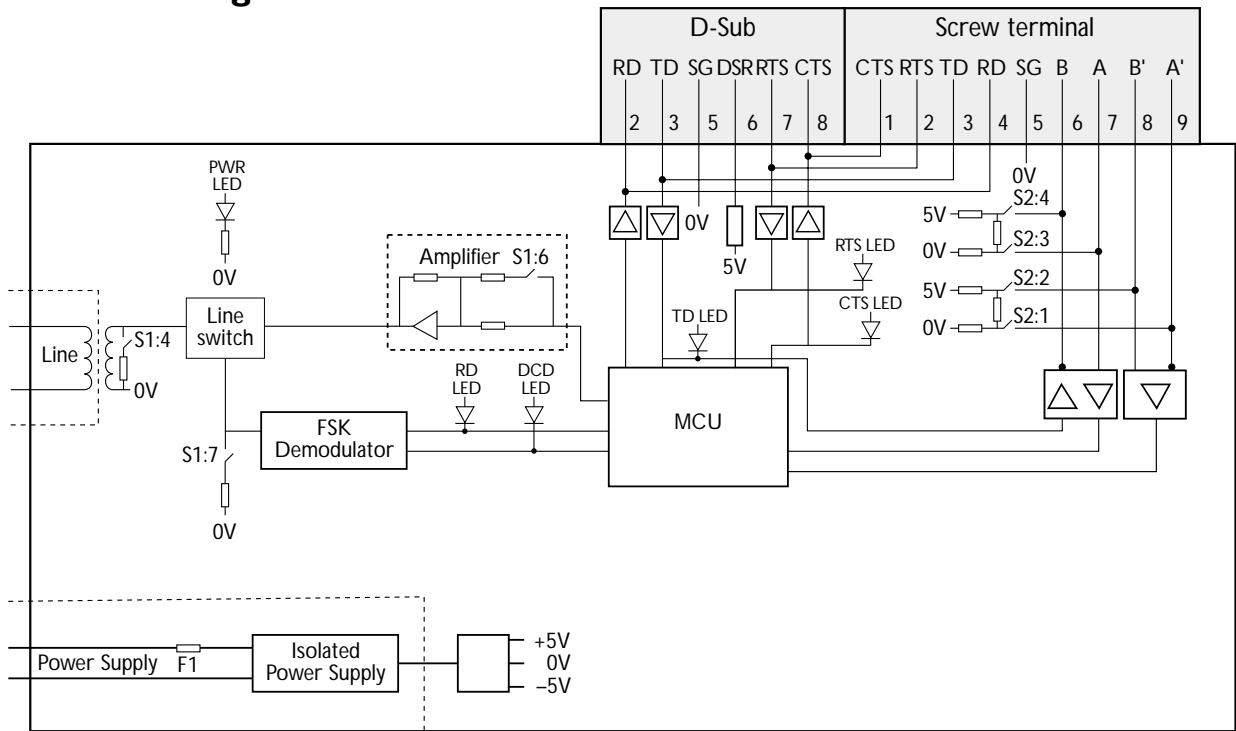

7.2 RS-422/485 connection

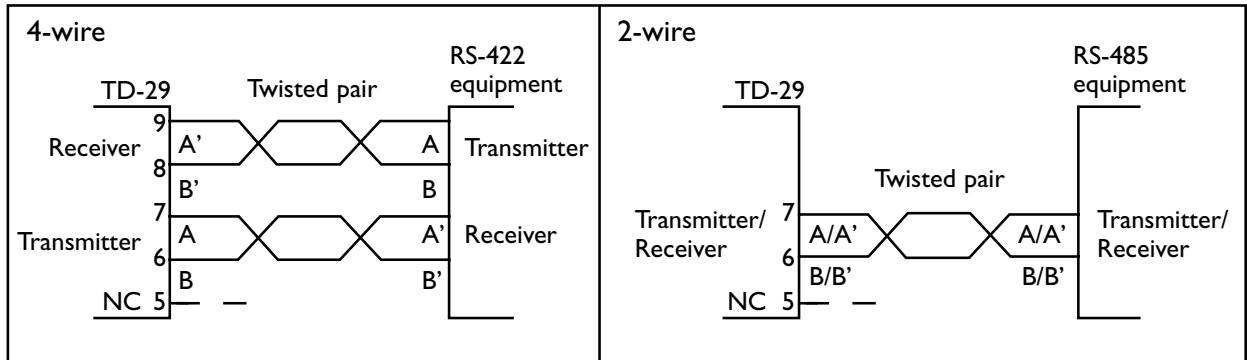

7.3 Line connection

2-position
detachable screw terminal

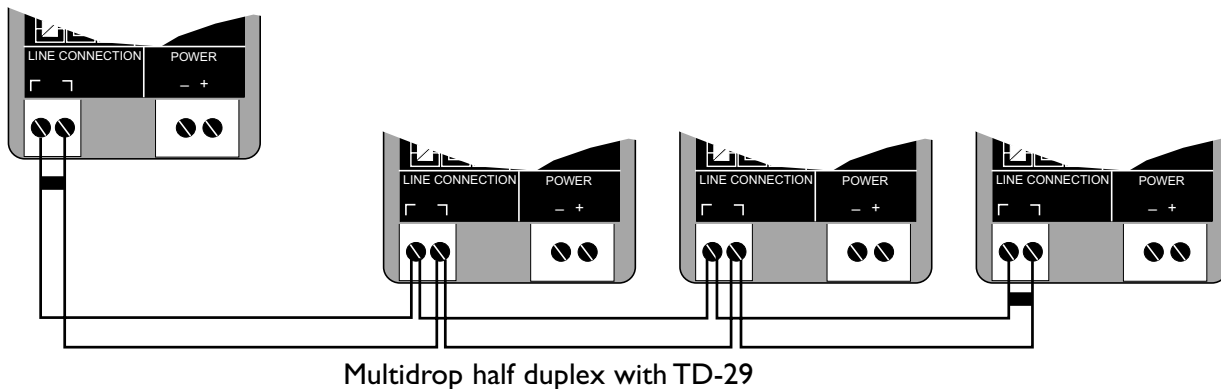

- Termination to be set with DIP-switches

Inhalt

1. Sicherheit	31
2. Zulassungen	31
2.1 Konformitätserklärung	32
3. Modem Beschreibung	33
4. Technische Daten	34–35
4.1 Anschlüsse	34
4.2 Isolation zwischen Schnittstelle	34
4.3 Umgebungsbedingungen	35
4.4 Mechanisches	35
4.5 Maximale Übertragungsweite und Signaldämpfungen	35
4.6 Umschaltzeit	35
5. Wartung	36
6. Installation	36–40
6.1 Montage/Demontage	36
6.2 Anschlüsse	37
6.3 LED Status Anzeigen	37
6.4 Schnittstelle 1 (RS-232)	38
6.5 Schnittstelle 2 (RS-422/485)	38
6.6 Schnittstelle 3	38
6.7 Spannungsversorgungs Anschluss DC	38
6.8 Spannungsversorgungs Anschluss AC	38
6.9 Konfiguration	39–40
6.9.1 DIP-Schalter Einstellung	40
7. Funktionsbeschreibung	41–42
7.1 Blockdiagramm	42
7.2 RS-422/485 Anschluss	42
7.3 Leitungsanschluss	43

1. Sicherheit



Allgemeines:

Vor dem Einsatz des Gerätes ist die Bedienungsanleitung vollständig zu lesen. Überprüfen Sie, dass der Einsatz dieser Geräte keine Vorschriften verletzt, und den Spezifikationen des Geräts entspricht.



Vor der Installation, Wartung oder Modifikation:

Vermeiden Sie Schaden an der Elektronik durch elektrostatische Aufladung (ESD) indem Sie sich vorher an einem Erdpunkt entladen (z.B. Einsatz eines Erdarmbandes).



Installation:

Dieses Gerät wurde für den professionellen Einsatz entwickelt. Es sollte nur in einem gesicherten Umfeld betrieben werden, zu dem nur Servicepersonal Zutritt hat.

Die Einheit ist zum permanenten Anschluss an AC/DC Spannungsversorgungen gedacht und darf nur von geeignetem Personal installiert werden.

Die AC/DC Versorgungsleitungen sind ausreichend abzusichern, und eine manuelle Unterbrechungsmöglichkeit ist bei Bedarf vorzusehen. Beachten Sie auch die nationalen Vorschriften zu diesem Thema.

Dieses Gerät ist ein Klasse II Einheit und benötigt keine Schutz Erde.

Zur Kühlung des Gerätes wird die Außenluft benutzt, daher sollte die Luftströmung um das Gerät nicht gestört sein.

Siehe Installationshinweise auf Seite 36

Das TD-29 wurde für private Standleitungen entwickelt, und ist nicht nach dem europäischen CTR15 (2-Draht Standleitungen) zugelassen.

2. Zulassungen

Konformität mit den Richtlinien 73/23/EEC (Niederspannungs Richtlinien) wurde erreicht auf der Basis des Standards EN 60950.

Konformität mit den Richtlinien 89/339/EEC (EMV Verträglichkeit) wurde erreicht auf der Basis der Standards EN 61000-6-2 (industrielle Einstrahlung) und EN 61000-6-3 (industrielle Abstrahlung).

2.1 Konformitätserklärung



Westermo Teleindustri AB

Declaration of conformity

The manufacturer Westermo Teleindustri AB
SE-640 40 Stora Sundby, Sweden

Herewith declares that the product(s)

Type of product	Model	Art no	Installation manual
DIN-rail	TD-29 AC	3611-0101,0104,0110	6611-2001
DIN-rail	TD-29 DC	3611-0001,0003,0004	6611-2001
DIN-rail	TD-29P	3611-0020	6611-2021

is in conformity with the following EC directive(s).

No	Short name
89/336/EEG	Electromagnetic Compatibility (EMC)
73/23/EEG	Low Voltage Directive - LVD

References of standards applied for this EC declaration of conformity.

No	Title	Issue
EN 61000-6-2	Immunity for industrial environments	2 (2001)
EN 55024	Information technology equipment ñ Immunity	1 (1998)
EN 61000-6-3	Emission standard for residential, commercial and light-industrial environments	1 (2001)
EN 60950	Safety of information technology equipment	6 (2000)

The last two digits of the year in which the CE marking was affixed: 03

Herewith declares that product(s) listed above is in conformity with

No	Title	Issue
FCC part 15	Radio frequency devices	

Hans Levin
Technical Manager
9th October 2003

Postadress/Postal address
S-640 40 Stora Sundby
Sweden

Tel.
016-428000
Int+46 16428000

Telefax
016-428001
Int+46 16428001

Postgiro
52 72 79-4

Bankgiro
5671-5550

Org.nr/
Corp. identity number
556361-2604

Registered office
Eskilstuna

3. Modem Beschreibung

Das TD-29 wurde für den Einsatz auf 2-Draht Kupferleitungen entwickelt (Twisted Pair). Multidrop oder Punkt zu Punkt Verbindungen sind möglich. Das TD-29 unterstützt halbduplex Übertragungen bis zu 19.2 Kbit/s.

Das TD-29 kann mittels DIP-Schaltern einfach auf die Umgebungsbedingungen eingestellt werden. Datenformat, Baudraten, Übertragungspegel, DCD Erkennungsempfindlichkeit und die Übertragungsschnittstelle sind einstellbar. DEE-Geräte können über RS-232 oder RS-422/485 angeschlossen werden. Die RS-232 Schnittstelle kann entweder über einen 9-poligen Sub-D oder eine Schraubklemme angeschlossen werden. Für die Übertragungsraten gibt es vier Einstellmöglichkeiten.

Bei Einsatz der RS-232 Schnittstelle kann die Richtungsumschaltung entweder über RTS oder ankommende Daten gesteuert werden.

Bei Multidropverbindungen ist die Anzahl der anschließbaren Geräte und die Übertragungsweite von der Leitungsqualität abhängig. (siehe Kapitel 4.5)

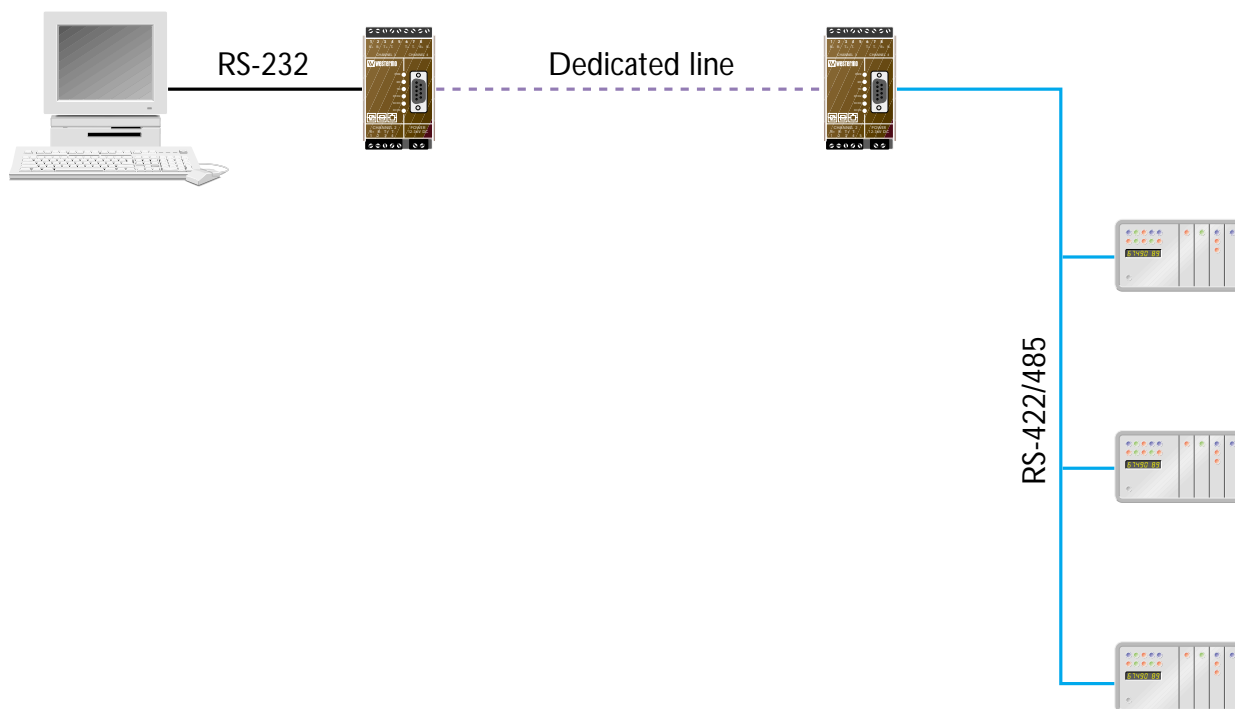

4. Technische Daten

4.1 Anschlüsse

Spannungsanschluss

	TD-29 AC	TD-29 DC	TD-29 36–55 VDC
Eingangsspannung	115 V/230 VAC	24 VDC	48 VDC
Betriebsspannung	104–132/207–264 VAC	12–36 VDC	36–55 VDC
Stromaufnahme	24 mA/12mA	200 mA	50 mA
Frequenz	48–62 Hz	–	–
Anschluss	3-pol Schraubklemme	2-pol Schraubklemme	2 pol Schraubklemme
Leitungsquerschnitt	0,2–2,5 mm ² (AWG 24-12)		

RS-422/485 Schnittstelle

Elektrische Daten	RS-422/485
Übertragungsrate	2 400 Bit/s–19.2 Kbit/s
Anschluss	5-pol. Schraubklemme
Leitungsquerschnitt	0,2–2,5 mm ² (AWG 24-12)
Anschlusstyp	TNV-1, Twisted Pair, Schirm nicht benötigt

RS-232 Schnittstelle

Elektrische Daten	RS-232
Übertragungsrate	2 400 Bit/s–19.2 Kbit/s
Anschluss	9-pol. Sub-D Buchse, DÜE
Anschlusstyp	SELV, max .15 m, Schirm nicht benötigt

FSK-Leitung Schnittstelle

Elektrische Daten	–
Übertragungsrate	2 400 Bit/s–19.2 Kbit/s
Anschluss	2 pol Schraubklemme
Leitungsquerschnitt	0,2–2,5 mm ² (AWG 24-12)
Anschlusstyp	TNV-3

4.2 Isolation zwischen den Schnittstellen

Netz zu allem	AC: 3 kV RMS @ 50 Hz und 60s Dauer DC: 1 kV RMS @ 50 Hz und 60s Dauer
FSK-Leitung Schnittstelle zu allem	1.5 kV RMS @ 50 Hz und 60s Dauer

4.3 Umgebungsparmeter

Betriebstemperatur	5–50°C
Lager- und Transport	–40 bis +85°C
Luftfeuchtigkeit	0 bis 95% (nicht kondensierend)
Lager- und Transport	0 bis 95% (Kondensation außerhalb Verpackung erlaubt)

4.4 Mechanisch

Abmessungen (B x H x T)	55 x 100 x 128 mm
Gewicht	0,5 kg
Montage	Schnappbar auf 35mm Hutschiene
Schutzart	IP20 (IEC 529)

4.5 Maximale Übertragungsweite und Signaldämpfungen

Übertragungsgeschwindigkeit (Bit/s)	Reichweite Punkt zu Punkt (Km)	Signaldämpfung (dB/km)	Dämpfung pro Gerät (Multidrop) (dB)
2 400	16	1,5	0,2
4 800	14	1,7	0,2
9 600	11	2,1	0,3
19 200	9	2,5	0,4

Gemessen mit Cat.5 Kabel UTP 4x2x24AWG. Signalpegel >–24 dBm. Die Buslänge hängt von der Leitungsqualität ab.

4.6 Umschaltzeit

RS-485

Datenrate Bit/s	Umschaltzeit µs
2 400	800
4 800	400
9 600	320
19 200	300

5. Wartung

Es sind keine Wartungsarbeiten erforderlich, solange das Gerät innerhalb der Spezifikation betrieben wird.

6. Installation

6.1 Montage/Demontage

Vor der Montage oder Demontage des Geräts:

Vermeiden Sie Schaden an der Elektronik durch elektrostatische Aufladung (ESD) indem Sie sich vorher an einem Erdpunkt entladen (z.B. Einsatz eines Erdarmbandes).

Um ein Berühren spannungsführender Teile zu vermeiden, ist das Gerät vor der Montage/Demontage von allen Spannungsführenden Teilen abzuklemmen.

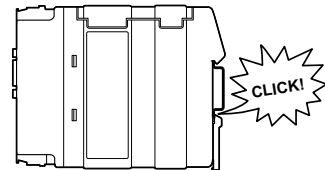
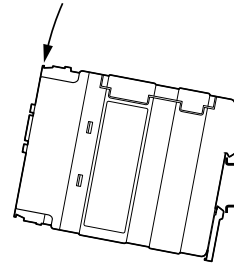

Montage

Das Gerät ist für die Montage auf einer horizontalen 35 mm Hutschiene vorgesehen. Zur Kühlung des Gerätes müssen bestimmte Mindestabstände eingehalten werden. Über und unter dem Gerät min. 25 mm (1.0 Inch) und links und rechts min. 10 mm (0.4 Inches).

Aufschnapp Montage (Skizze)

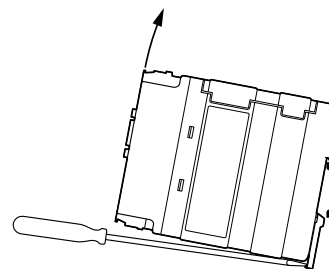
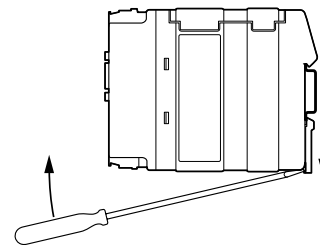
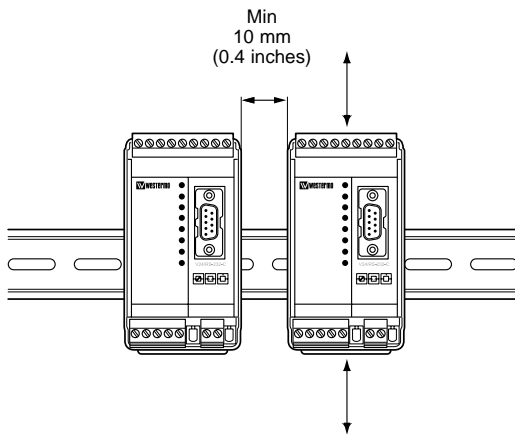

Demontage

Die schwarze Halterung auf der Unterseite mit einem Schraubendreher nach unten ziehen und das Gerät nach oben von der Hutschiene nehmen (Skizze).

6.2 Anschlüsse

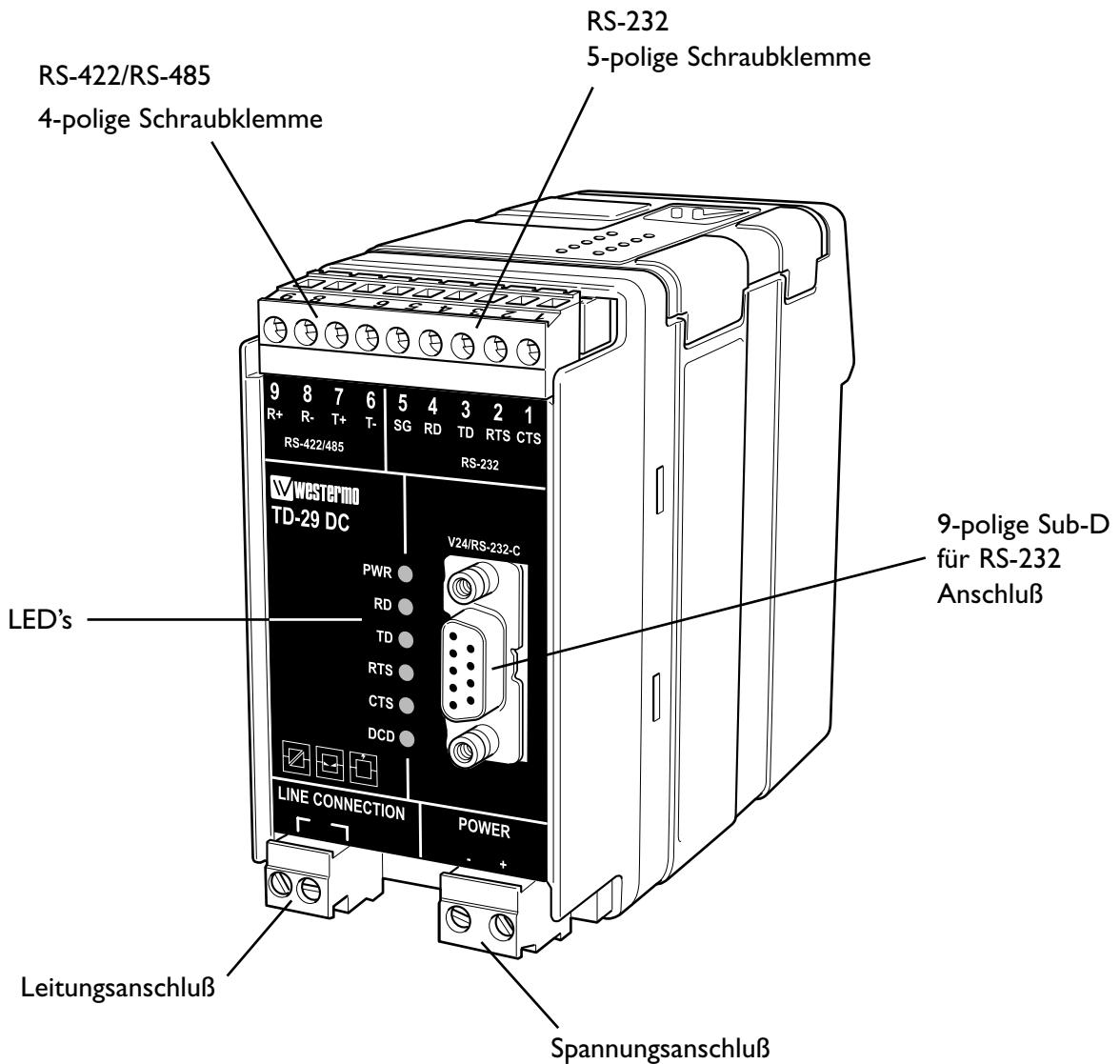

6.3 LED Status Anzeigen

PWR	LED on LED off	Power on Power off
RD	LED on LED off	Receive Line Data active Receive Line Data inactive
TD	LED on LED off	Transmit Line Data active Transmit Line Data inactive
RTS	LED on LED off	Request To Send aktive Request To Send inaktive
DCD	LED on LED off	Data Carrier Detect active Data Carrier Detect inactive
CTS	LED on LED off	Clear To Send active Clear To Send inactive

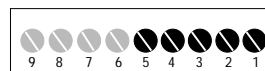
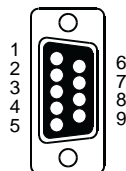

6.4 Schnittstelle 1 (RS-232)

9-pol. Sub-D Pin-Nr.	9-pol Schraubklemme	Richtung	Beschreibung
1	–	–	–
2	4	Aus	RD/Received Data
3	3	In	TD/Transmitted Data
4	–	–	–
5	5	–	SG/Signal Ground
6	–	Aus	DSR/Data Set Ready
7	2	In	RTS/Request to Send
8	1	Aus	CTS/Clear to Send
9	–	–	–

6.5 Schnittstelle 2 (RS-422/485)

9-pol Schraubklemme	Richtung	ITU-T V.11 Beschreibung	Beschreibung
9	In	A' (R+)	RS-422 Empfänger
8	Aus	B' (R-)	RS-422 Empfänger
7	In/Aus	A (T+)	RS-422/485 Sender/Empfänger
6	In/Aus	B (T-)	RS-422/485 Sender/Empfänger

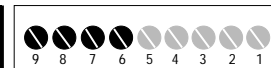

Die Bezeichnungen R+/R-, T+/T- können Herstellerabhängig variieren.

6.6 Schnittstelle 3

Anschluss Nr.	2-pol Schraubklemme	Beschreibung
1	In/Aus	Sender/Empfänger
2	In/Aus	(2-Draht)



6.7 Spannungsversorgungs Anschluss DC

Klemme Nr	Beschreibung	Spannungsversorgung
1	–	0 VDC
2	+	12–55 VDC



6.8 Spannungsversorgungs Anschluss AC

Klemme Nr	Spannungsversorgung
L	115*/230 VAC
N	115*/230 VAC
	PE/Schutzerde



* 115V AC Sonderversion

6.9 Konfiguration

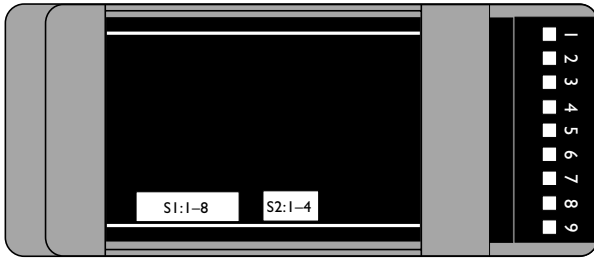

6.9.1 DIP-Schalter Einstellungen

Die DIP-Schalter befinden sich unter der oberen Abdeckung des Gerätes.
Die DIP-Schalter werden zur Konfiguration verwendet.



Warnung!

Vermeiden Sie Schaden an der Elektronik durch elektrostatische Aufladung (ESD) indem Sie sich vorher an einem Erdpunkt entladen (z.B. Einsatz eines Erdarmbandes), bevor Sie die Abdeckung abnehmen.



Warnung! Keine unter Spannung stehenden Geräte öffnen.

Um Berührungen mit der Versorgungsspannung zu vermeiden, sind die geräte vor der Einstellung immer Spannungslos zu schalten.

Hinweis

Die DIP-Schalter werden immer erst nach einem Spannungsreset eingelesen. Eine Einstellung während des Betriebes überschreibt die DIP-Schalter Einstellung. Jedoch wird beim nächsten Reset die aktuelle DIP-Schalter Einstellung eingelesen.
Die DIP-Schalter haben vorrang vor allen anderen Konfigurationen.

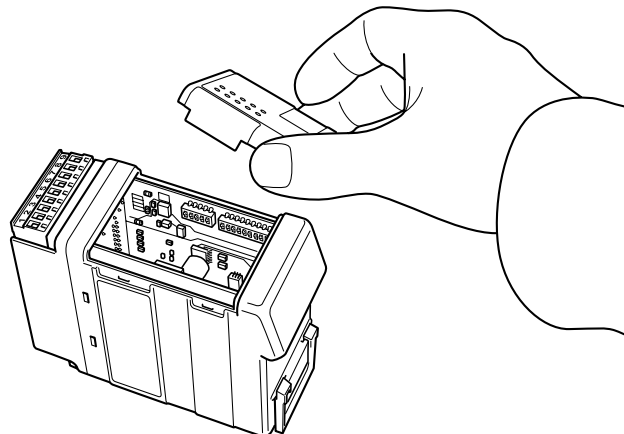

DIP-Schalter 1 – S1

Datenformat

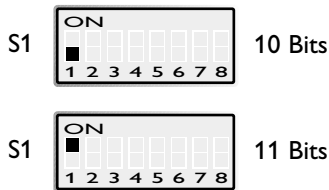

Sender Aktivierung mit RTS oder empfangenen Daten

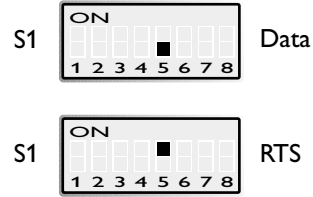

Baudrate

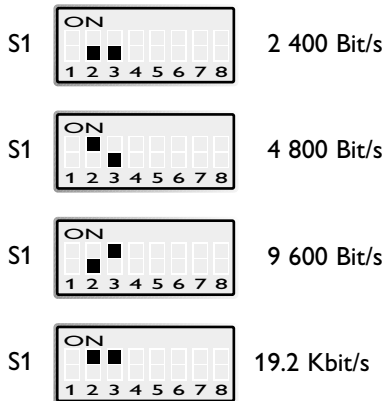

Übertragungspegel*

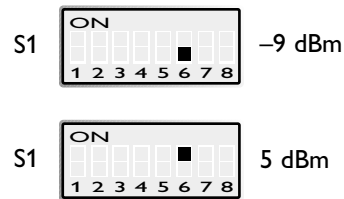

* Bei 600 Ω

Leitungstermination*

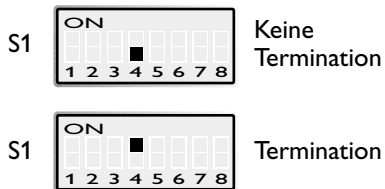

* Die Termination sollte an den Endstellen der Leitung gesetzt sein.

DCD Empfindlichkeit

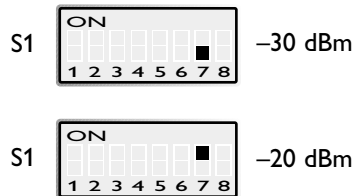

S1: 8 nicht benutzt

DIP-Schalter 2 – S2

RS-422 Termination*

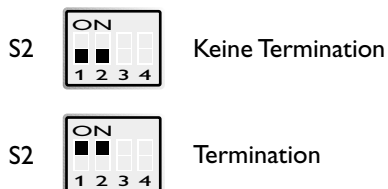

* Die Termination sollte an den Endstellen der Leitung gesetzt sein.

RS-485 Termination*

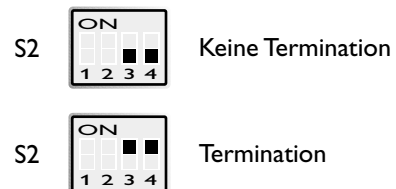

* Die Termination sollte an den Endstellen der Leitung gesetzt sein.

Werkseinstellung



7. Funktionsbeschreibung

7.1 Blockdiagramm

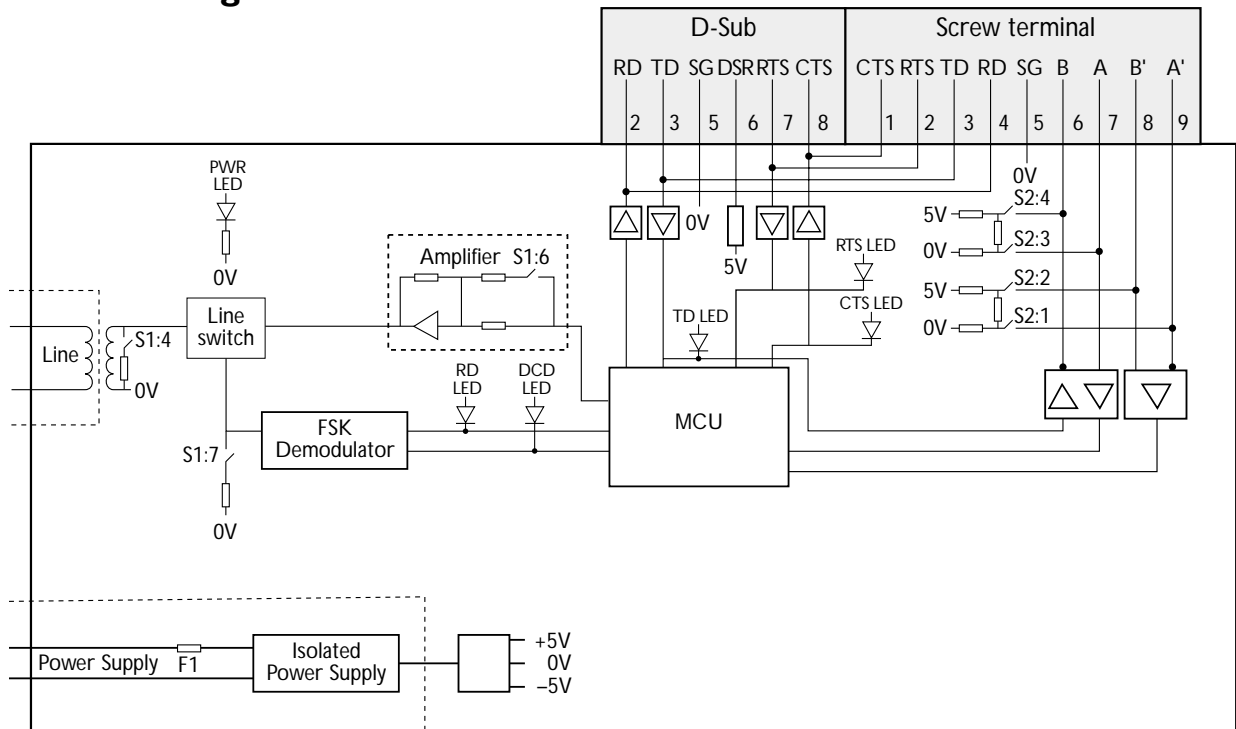

7.2 RS-422/485 Anschluss

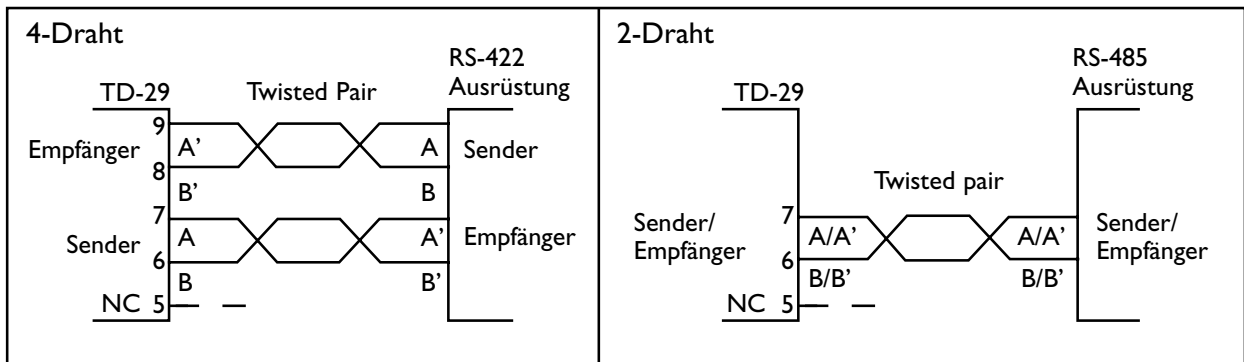

7.3 Leitungsanschluss

2-polige Schraubklemme

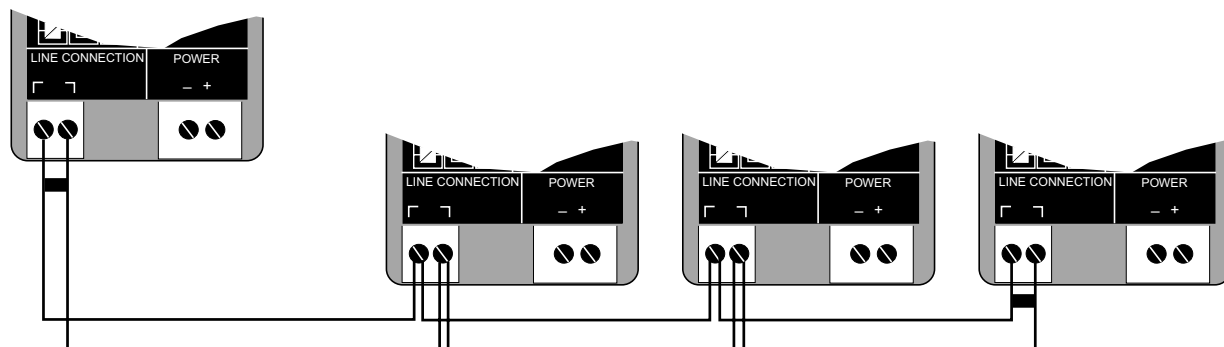

Multidrop Halbduplex mit TD-29

- Termination, mit DIP-Schalter schaltbar

Sommaire

1. Sécurité	45
2. Homologations	45
2.1 Déclaration de conformité	46
3. Description du modem	47
4. Spécifications	48–49
4.1 Connexions	48
4.2 Isolation entre interfaces	48
4.3 Environnement climatique	49
4.4 Mécanique	49
4.5 Performance de transmission et atténuation	49
4.6 Temps de retournement	49
5. Maintenance	50
6. Installation	50–54
6.1 Fixation / Dépose	50
6.2 Connexions	51
6.3 Indicateurs de Statut LED	51
6.4 Interface 1 (RS-232)	52
6.5 Interface 2 (RS-422/485)	52
6.6 Interface 3	52
6.7 Connexion alimentation DC	52
6.8 Connexion alimentation AC	52
6.9 Configuration	53–54
6.9.1 Interrupteurs DIP	53
7. Description fonctionnelle	55–56
7.1 Schéma simplifié	55
7.2 Connexion RS-422/485	55
7.3 Connexion ligne	56

1. Sécurité



Généralités:

Lire le manuel d'installation en détails et s'assurer de la bonne compréhension de son contenu avant de mettre en service cet équipement.
Vérifier que votre application n'excède pas les spécifications technique de fonctionnement de cet équipement.



Avant toute intervention sur ce matériel:

Afin d'éviter tout risque de destruction par décharges électrostatiques (OSD) des éléments internes, Référencez votre corps à la terre. (Par ex:utiliser des bracelets electrostatique).



Installation:

Cet équipement est conçu pour un usage industriel. il doit être installé dans un local technique dont l'accès est limité au seules personnes autorisées.

Cet équipement est destiné a être alimenté en permanence à une source AC/DC et ne peut être installé que par du personnel qualifié.

La source d'alimentation AC/DC doit être équipée avec des protections électriques adaptées et doit permettre autant que possible de débrancher manuellement l'équipement.

S'assurer de la bonne conformité de l'installation avec la réglementation nationale en vigueur.

Cet équipement est de classe II et ne doit pas être raccorder à la terre.

Cet équipement utilise une ventilation par convection.Veiller à laisser suffisamment d'espace tout autour de celui-ci pour permettre une bonne ventilation.

(Se reporter au chapitre Installation).

Le TD-29 a été conçu pour être utilisé sur des lignes privées et n'est donc pas homologué au standard Européen CTR-15 (ligne louée 2 fils).

2. Homologations

La conformité à la directive 73/23/EEC (Directive basse tension) à été obtenue par l'application du standard EN 60950.

La conformité à la directive 89/339/EEC (compatibilité electromagnétique) à été obtenue par application des standards EN 61000-6-2 (immunité industrielle) et EN 61000-6-3 (émission résidentielle).

2.1 Déclaration de conformité



Westermo Teleindustri AB

Declaration of conformity

The manufacturer Westermo Teleindustri AB
SE-640 40 Stora Sundby, Sweden

Herewith declares that the product(s)

Type of product	Model	Art no	Installation manual
DIN-rail	TD-29 AC	3611-0101,0104,0110	6611-2001
DIN-rail	TD-29 DC	3611-0001,0003,0004	6611-2001
DIN-rail	TD-29P	3611-0020	6611-2021

is in conformity with the following EC directive(s).

No	Short name
89/336/EEG	Electromagnetic Compatibility (EMC)
73/23/EEG	Low Voltage Directive - LVD

References of standards applied for this EC declaration of conformity.

No	Title	Issue
EN 61000-6-2	Immunity for industrial environments	2 (2001)
EN 55024	Information technology equipment ñ Immunity	1 (1998)
EN 61000-6-3	Emission standard for residential, commercial and light-industrial environments	1 (2001)
EN 60950	Safety of information technology equipment	6 (2000)

The last two digits of the year in which the CE marking was affixed: 03

Herewith declares that product(s) listed above is in conformity with

No	Title	Issue
FCC part 15	Radio frequency devices	

Hans Levin
Technical Manager
9th October 2003

Postadress/Postal address
S-640 40 Stora Sundby
Sweden

Tel.
016-428000
Int+46 16428000

Telefax
016-428001
Int+46 16428001

Postgiro
52 72 79-4

Bankgiro
5671-5550

Org.nr/
Corp. identity number
556361-2604

Registered office
Eskilstuna

3. Description du modem

Le TD-29 a été conçu pour des liaisons en paire torsadée (2 fils) point à point ou multipoints. Le TD-29 supporte une vitesse pouvant aller jusqu'à 19 200 bit/s en half duplex.

La configuration du TD-29 s'effectue simplement à l'aide de micro-interrupteurs DIP.

Les paramètres suivants sont configurables : format des caractères, vitesse, niveau de transmission, niveau de détection de la porteuse DCD, et le type d'interface de transmission.

Le TD-29 peut être raccordé vers une interface RS-232 ou RS-422/485.

Le raccordement RS-232 peut se faire depuis le connecteur Sub-D9 ou bien depuis le bornier à vis détachable situé sur la façade du modem. Il y a 4 niveaux de débit de données configurable.

Lorsque l'on utilise l'interface RS-232, la direction du flux des données peut être pilotée par le signal de contrôle de flux RTS ou bien par la détection de la direction du flux de données.

Dans le cas d'une application multipoints, le nombre maximum de modems que l'on peut connecter sur le bus et la longueur du réseau dépendent de la qualité de la ligne. (4.5)

La valeur typique à 9 600 bit/s, est de 10 unités pour une distance de 10 Km.*

Le TD-29 a été conçu pour être utilisé sur des lignes privées et n'est donc pas homologué au standard Européen CTR-15 (ligne louée 2 fils).

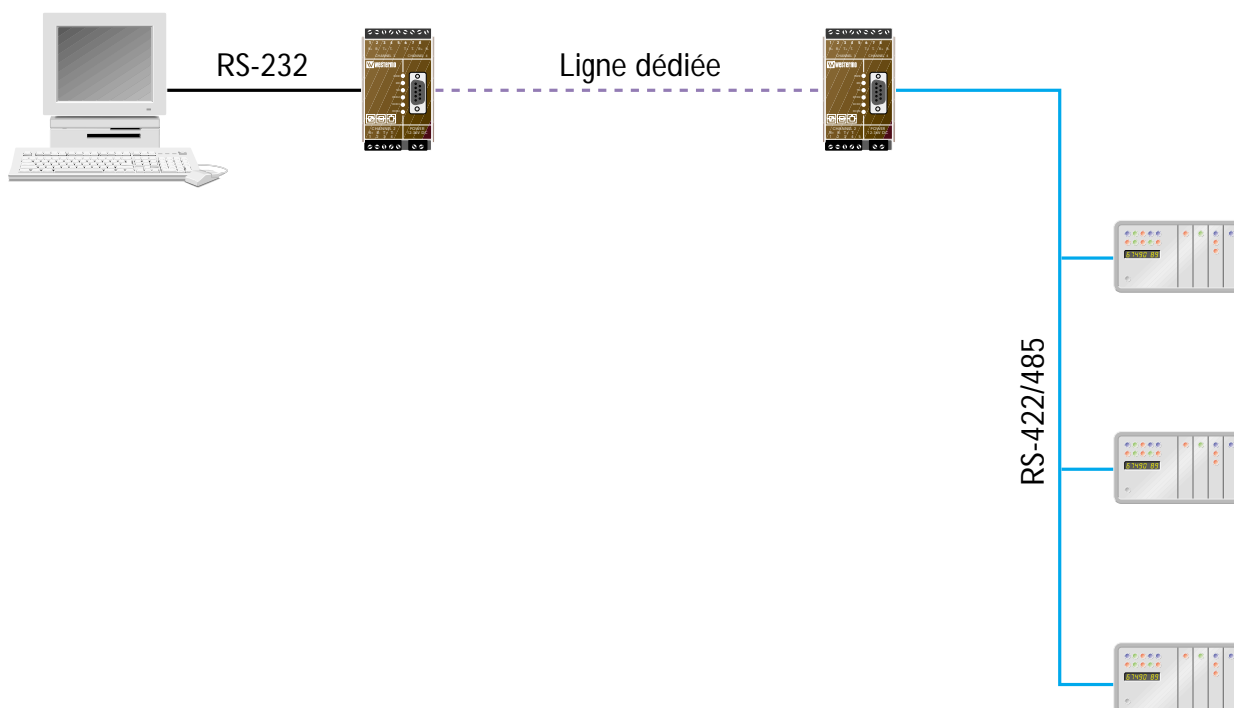

* Le nombre d'unité et la longueur du bus ont été calculés pour un câble ayant une résistivité de 123 Ohm et une capacité de 42nf/km

4. Spécifications

4.1 Connexions

Alimentation

	TD-29 AC	TD-29 DC	TD-29 36–55 VDC
Tension d'alimentation	115 V/230 VAC	24 VDC	48 VDC
Plage d'alimentation	104–132/207–264 VAC	12–36 VDC	36–55 VDC
Consommation	24 mA/12 mA	200 mA	50 mA
Fréquence	48–62 Hz	–	–
Connexion	Bornier à vis 3 positions	Bornier à vis 2 positions	Bornier à vis 2 positions
Section des conducteurs	0,2–2,5 mm ² (AWG 24-12)		

Interface RS-422/485

Spécification Electrique	RS-422/485
Vitesse de transmission	2 400 bit/s–19.2 kbit/s
Connexion	Bornier à vis 5 positions
Section conducteurs	0,2–2,5 mm ² (AWG 24-12)
Type de Circuit	TNV-1, paire torsadée, blindage non requis

Interface RS-232

Spécification Electrique	RS-232
Vitesse de transmission	2 400 bit/s–19.2 kbit/s
Connexion	sub-D 9 positions, DCE
Type de circuit	SELV, longueur 15 m max, blindage non requis

Interface Ligne FSK

Spécification Electrique	–
Vitesse de transmission	2 400 bit/s–19.2 kbit/s
Connexion	Bornier à vis 2 positions
Section conducteurs	0,2–2,5 mm ² (AWG 24-12)
Type de Circuit	TNV-3

4.2 Isolation entre interfaces

Alimentation vers toutes autres	AC: 3 kV RMS @ 50 Hz et durant 60s DC: 1 kV RMS @ 50 Hz et durant 60s
Ligne FSK vers toutes autres	1.5 kV RMS @ 50 Hz et durant 60s

4.3 Environnement climatique

Température en fonctionnement	5–50°C
Température, transport et stockage	–40 to +85°C
Humidité relative en fonctionnement	0 à 95% (non condensé)
Humidité relative Transport et stockage	0 à 95% Condensation permise à l'extérieur de l'emballage

4.4 Mécanique

Dimension (L x H x P)	55 x 100 x 128 mm
Poids	0,5 kg
Fixation	Rail-DIN 35 mm
Indice de protection	IP 20 (IEC 529)

4.5 Performance de transmission et atténuation

Vitesse de Transmission (bit/s)	Distance point à point (km)	Atténuation du signal (dB/km)	Atténuation par modem (Multi-point) (dB)
2 400	16	1,5	0,2
4 800	14	1,7	0,2
9 600	11	2,1	0,3
19 200	9	2,5	0,4

Mesuré avec du câble de Cat 5 UTP 4x2x24 AWG. Niveau du signal >–24 dBm.
La longueur du bus dépend de la qualité de la ligne.

4.6 Temps de retournement

RS-485

Vitesse bit/s	Temps retournement µs
2 400	800
4 800	400
9 600	320
19 200	300

5. Maintenance

Aucune intervention est nécessaire tant que l'équipement est utilisé dans les conditions spécifiées.

6. Installation

6.1 Fixation / Dépose

Recommandations avant de fixer ou de déposer l'équipement:

Afin d'éviter tout risque de destruction par décharges électrostatiques (ESD) des éléments internes, Référez votre corps à la terre (Par ex: utiliser des bracelets électrostatiques).

Débrancher l'équipement de la source d'alimentation AC/DC ainsi que toutes les autres connexions pour éviter tout risque d'électrocution.

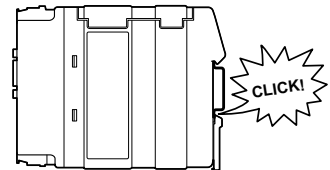
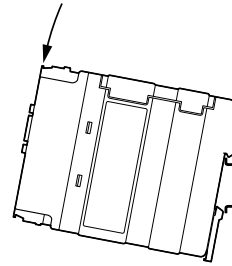

Fixation

Cet équipement doit être installé sur un rail DIN 35 mm fixé horizontalement sur un mur ou dans une armoire technique.

Cet équipement utilise une ventilation par convection. Laisser un dégagement suffisant autour de l'équipement en suivant les instructions suivantes: Zone de dégagement recommandée, Dessus/Dessous: 25 mm.

Droite/Gauche: 10 mm.

Fixation par verrouillage (Voir Figure)

Dépose

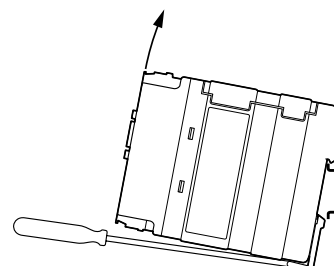
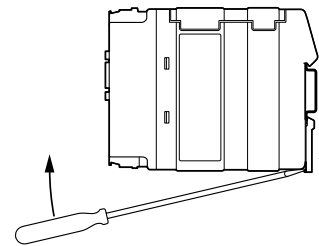
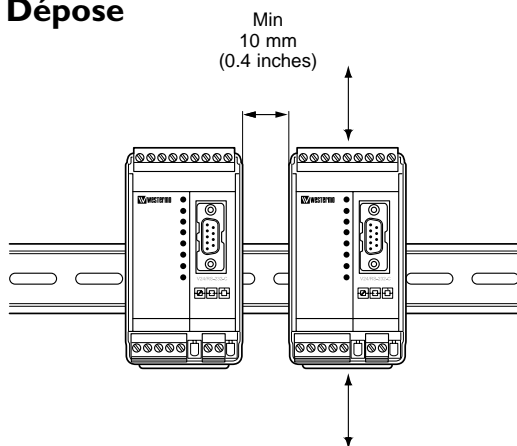

Tirez l'agraffe noire situé au dos de l'équipement vers le bas à l'aide d'un tournevis. (Voir Figure).

6.2 Connexions du TD-29

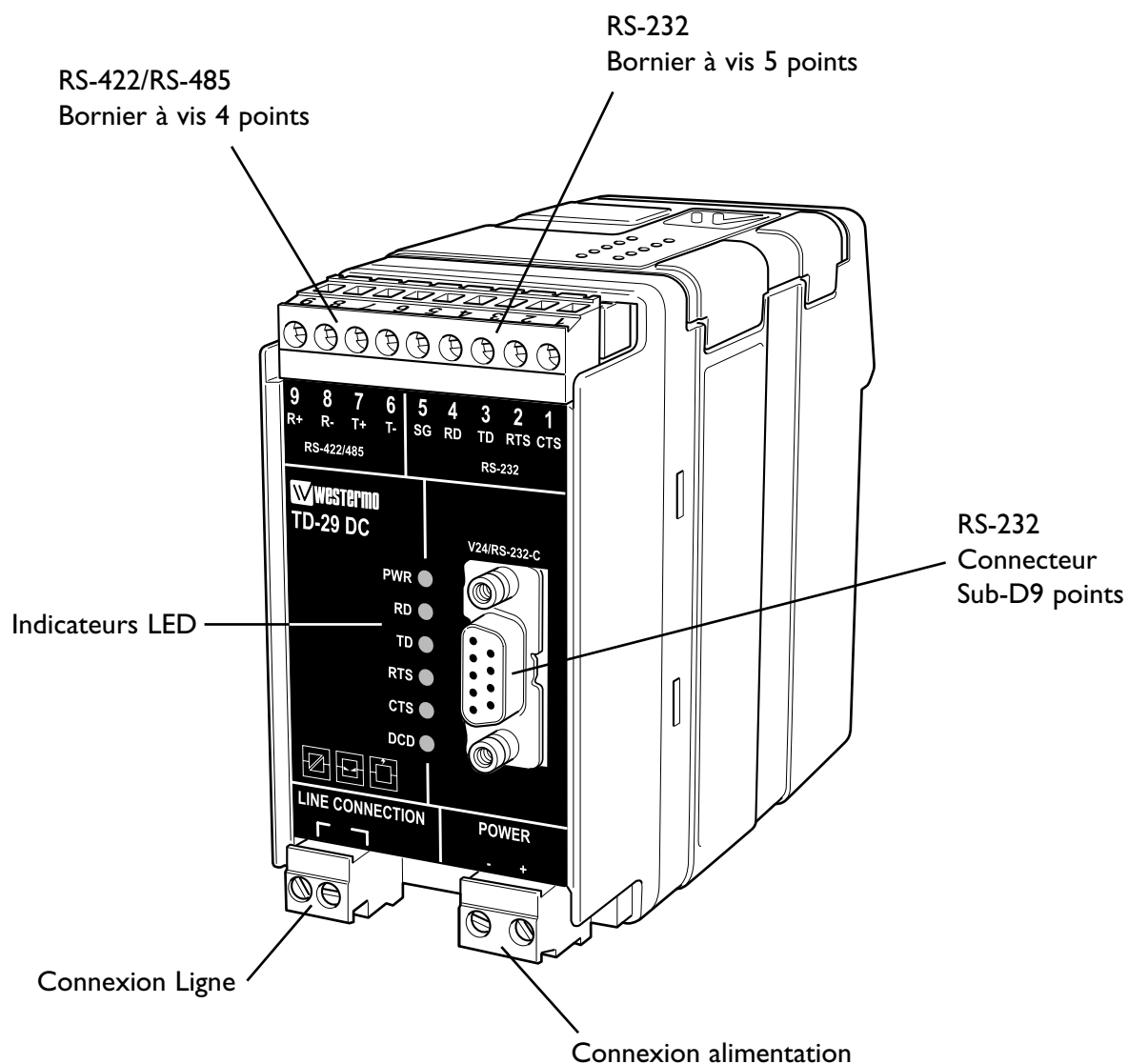

6.3 Indicateurs de Statut LED

PWR	LED Allumée LED Eteinte	LED Eteinte Pas d'alimentation
RD	LED Allumée LED Eteinte	Réception de données sur la ligne Aucune donnée reçue
TD	LED Allumée LED Eteinte	Transmission de données sur la ligne Aucune donnée transmise
RTS	LED Allumée LED Eteinte	Signal RTS Actif Signal RTS Inactif
DCD	LED Allumée LED Eteinte	Détection de porteuse active Détection de porteuse inactive
CTS	LED Allumée LED Eteinte	Signal CTS actif Signal CTS inactif

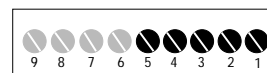
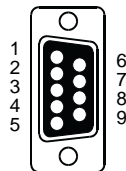

6.4 Interface 1 (RS-232)

Sub-D 9 pos. Broche N°	9-pos. Bornier à vis	Direction	Description
1	–	–	–
2	4	Sortie	RD / Donnée Reçue
3	3	Entrée	TD / Donnée Transmise
4	–	–	–
5	5	–	SG / Masse
6	–	Sortie	DSR / Data Set Ready
7	2	Entrée	RTS / Request to Send
8	1	Sortie	CTS / Clear to Send
9	–	–	–

6.5 Interface 2 (RS-422/485)

Bornier à vis 9-pos.	Direction	Description ITU-TV.24	Description
9	Entrée	A' (R+)	RS-422 Récepteur
8	Sortie	B' (R-)	RS-422 Récepteur
7	Entrée/Sortie	A (T+)	RS-422/485 Emetteur/Récepteur
6	Entrée/Sortie	B (T-)	RS-422/485 Emetteur/Récepteur

Les définitions R+/R-, T+/T- peuvent changer suivant les constructeurs.

6.6 Interface 3

Bornier N 2-pos.	Direction	Description
1	Entrée/Sortie	Emetteur/Récepteur (2 fils)
2		



6.7 Connexion alimentation DC

Bornier N°	Description	Alimentation
1	–	0V DC
2	+	12–55 VDC



6.8 Connexion alimentation AC

Bornier	Alimentation
L	115*/230 VAC
N	115*/230 VAC
	Terre de protection



*Version Spéciale 115 VAC

6.9 Configuration



6.9.1 Interrupteurs DIP

Les Interrupteurs DIP se trouvent sous le capot supérieur de l'équipement. Ils permettent la configuration du modem.



Attention!

Avant de démonter le capot du modem, référez votre corps à la terre (Par ex: utiliser des bracelets électrostatiques).

Afin d'éviter tout risque de destruction par décharges électrostatiques (OSD) des éléments internes,



Attention! Ne pas ouvrir un équipement sous tension.

Pour éviter tout risque d'électrocution.

débrancher l'équipement de la source d'alimentation AC/DC ainsi que toutes les autres connexions.

Remarque

Lorsque la configuration est réalisée par les interrupteurs DIP, la prise en compte de celle-ci est effective après avoir éteint et rallumé le modem.

Toute autre commande de configuration définie par la suite au cours du fonctionnement normal, ira modifier la configuration initiale des interrupteurs DIP.

Cependant, à la mise sous tension seule la configuration par interrupteurs DIP est prioritaire.

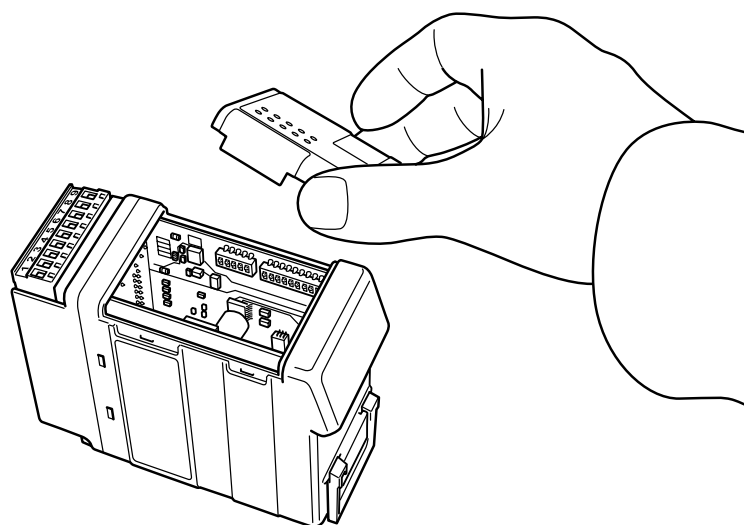

Interrupteurs DIP 1 – S1

Format caractère

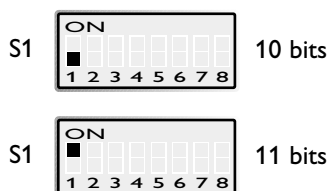

Activation de porteuse avec RTS ou flux de données

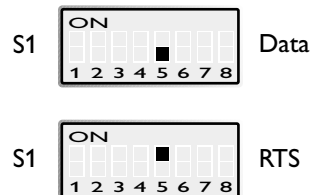

Vitesse transmission

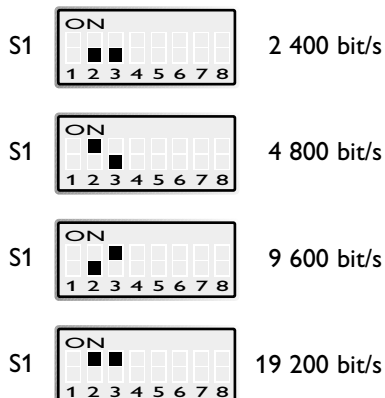

Configuration du niveau de transmission*

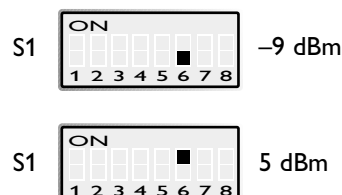

* Charge 600 Ω

Terminaison de ligne*

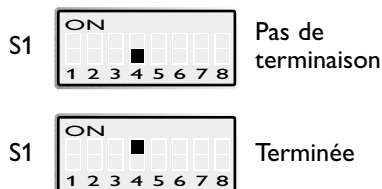

* La ligne devrait être terminée à chaque extrémité

Configuration du niveau minimum de détection DCD

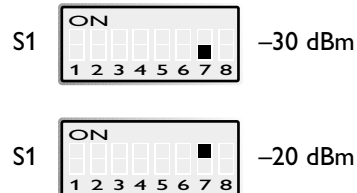

S1:8 Non utilisé.

Interrupteurs DIP 2 – S2

Terminaison RS-422*

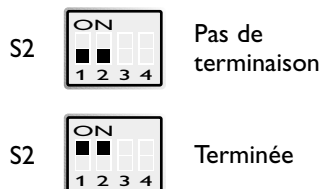

* La ligne devrait être terminée à chaque extrémité

Terminaison RS-485*

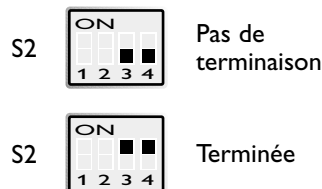

* La ligne devrait être terminée à chaque extrémité

Configuration Usine



7. Description fonctionnelle

7.1 Schéma simplifié

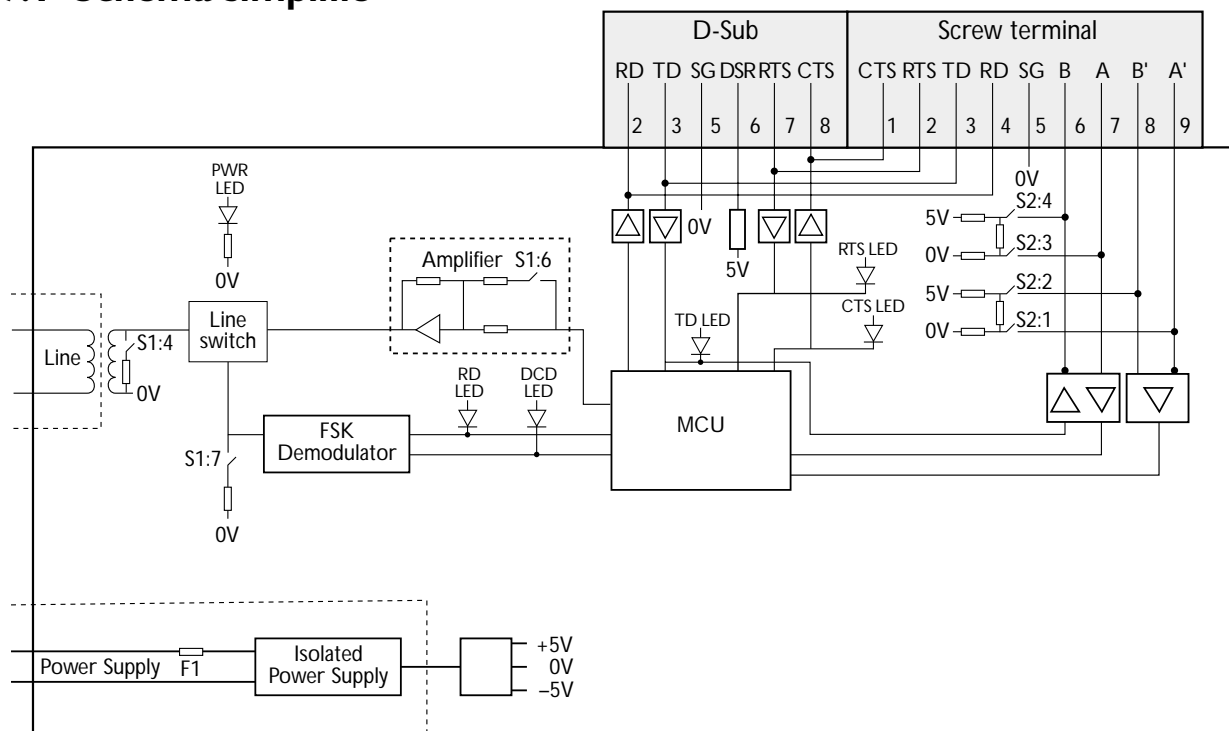

7.2 Connexion RS-422/485

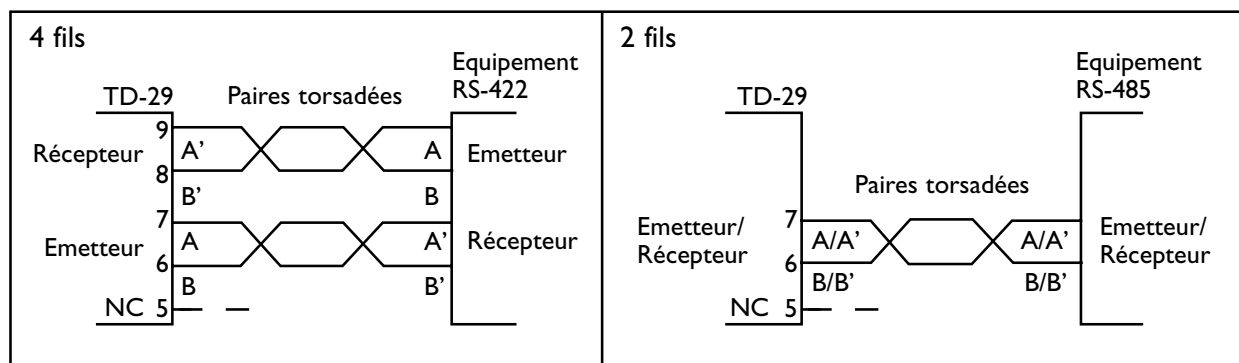

7.3 Connexion Ligne

Bornier à vis détachable à 2 positions

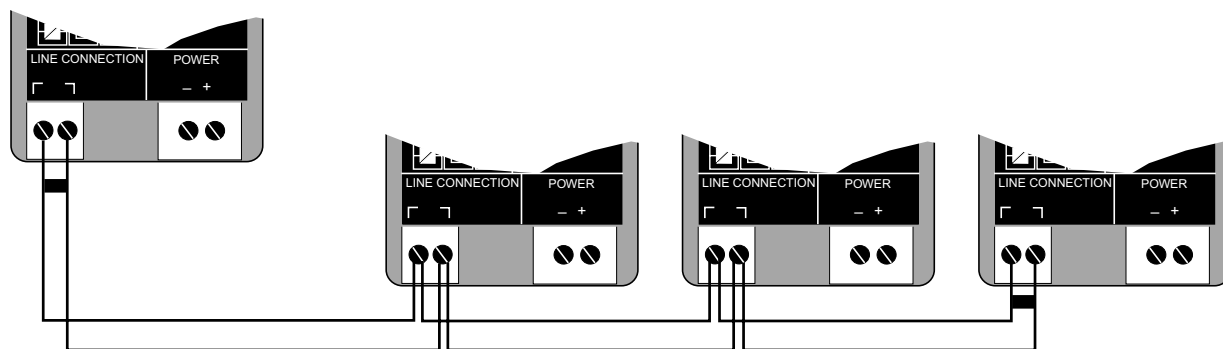

Liaison multipoint half duplex avec le TD-29

- Terminaison à configurer avec les micro-interrupteurs DIP

Application example

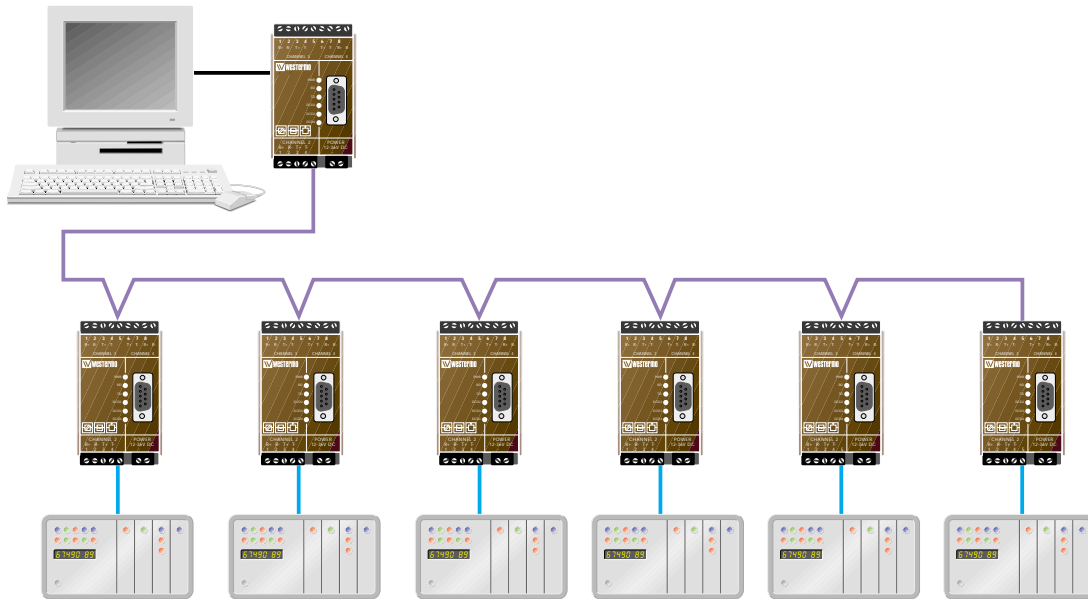

Westermo Teleindustri AB • SE-640 40 Stora Sundby, Sweden

Phone +46 16 42 80 00 Fax +46 16 42 80 01

E-mail: info@westermo.se

Westermo Web site: www.westermo.com

Subsidiaries

Westermo Data Communications Ltd
Unit 14 Talisman Business Centre • Duncan Road
Park Gate, Southampton • SO31 7GA
Phone: +44(0)1489 580 585 • Fax: +44(0)1489 580586
E-Mail: sales@westermo.co.uk

Westermo Data Communications GmbH
Goethestraße 67, 68753 Waghäusel
Tel.: +49(0)7254-95400-0 • Fax: +49(0)7254-95400-9
E-Mail: info@westermo.de

Westermo Data Communications S.A.R.L.
9 Chemin de Chilly 91160 CHAMPLAN
Tél : +33 1 69 10 21 00 • Fax : +33 1 69 10 21 01
E-mail : infos@westermo.fr

Westermo Teleindustri AB have distributors in several countries, contact us for further information.