

MD-63D

# INSTALLATIONSANVISNING INSTALLATION MANUAL INSTALLATIONS ANLEITUNG

6071-2081

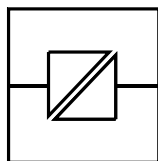

Galvanic  
Isolation

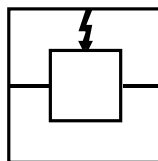

Transient  
Protection

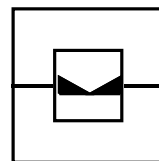

Balanced  
Transmission

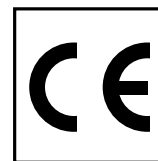

CE  
Approved

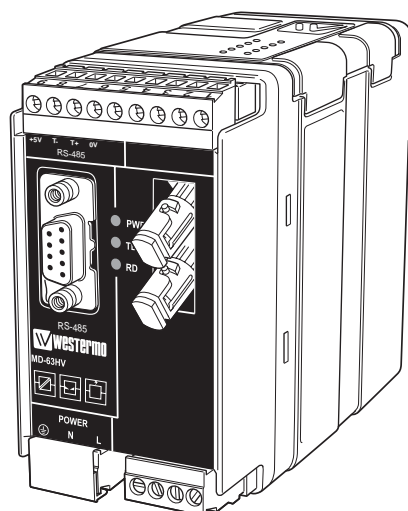

***Omvandlare Opto – RS-485  
Converter Opto – RS-485  
Glasfaser Wandler – RS-485***

 **westermo**<sup>®</sup>

[www.westermo.se](http://www.westermo.se)

<sup>®</sup>**WESTERMO**

## Funktionsbeskrivning MD-63D

MD-63D är utvecklad för RS-485 punkt till punkt kommunikation samt omvandling mellan RS-485 och fiber. Enheten har en 9-polig standard D-sub för anslutning till RS-485. Möjlighet att ansluta RS-485 till skruvplint (5-polig) finns också.

Fibergränssnittet är bestyckat med ST-kontakter och finns i olika versioner beroende på vilken fiberkabel som används (singel-/multimode). Överföringsavstånd beräknas från tillgänglig effektbudget hos modemen och förluster i kabel, kontakter och skarvar är viktiga parametrar. Överföringsavstånd upp till 25 km är möjliga med singelmodkabel. Den fiber-optiska kabeln är helt okänslig mot yttre störningar, vilket gör att den lämpar sig väl i störningsrika miljöer.

Modemet består av en fiberkanal med en sändare respektive mottagare. På frontpanelen finns dessutom 3 st lysdioder som ger indikering av datatrafiken på kanalen.

MD-63D kan användas med hastigheter upp till 1.5 Mbit/s, alla inställningar på modemet är lättillgängliga genom switchar på varje enhet.

MD-63D är tillgänglig i låg (LV) och högspännings (HV) variant. MD-63D LV stöder inspänningsområden 12–45V AC  $\pm$  5% samt 12–55V DC  $\pm$  5%. MD-63D HV stöder inspänningsområden 95–240V AC  $\pm$  5% samt 110–240V DC  $\pm$  5%.

## Specifikationer MD-63D

<b>Överföring</b>	Asynkront, full/halv duplex eller simplex
<b>Gränssnitt 1</b>	EIA RS-485 / ITU-T V.11 RS-485 9-pol D-sub alt. 5-polig skruvplint
<b>Gränssnitt 2</b>	Fiberoptiskt 2 ST-kontakter
<b>Överföringshastigheter</b>	Upp till 1.5 Mbit/s
<b>Lysdioder</b>	PWR, TD, RD
<b>Temperaturområde</b>	5–50°C omgivningstemperatur
<b>Fuktighetsområde</b>	0–95% RH utan kondensation
<b>Mått</b>	55x100x128 mm (BxHxD)
<b>Vikt</b>	0,4 kg
<b>Montering</b>	På 35 mm DIN-skena
<b>Matningsalternativ</b>	

Modellbeteckning	MD-63D HV	MD-63D LV
Strömförsörjning	95–240 V AC $\pm$ 10% / 110–240 V DC $\pm$ 10%	12–45 V AC $\pm$ 10% / 12–55 V DC $\pm$ 10%
Frekvens	48–62 Hz / –	48–62 Hz / –
Säkring, FI	I A T / IA T Wickmann	I A T / IA T Wickmann
Effektförbrukning	40 mA	3 W
Överspänningsskydd	430 V	430 V
Isolationsspänning, RMS	3 750 V	3 750 V







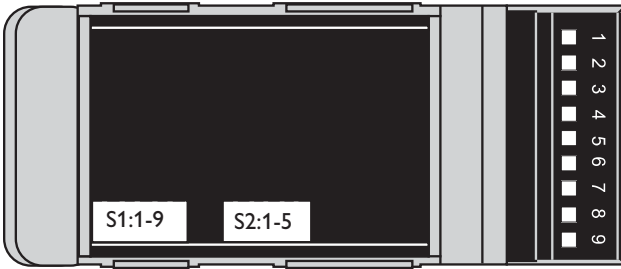







## Lysdiodindikeringar MD-63D

- PWR: Indikerar att enheten är spänningssatt.
- TD: Indikerar mottagen data på RS-485 sidan.
- RD: Indikerar sänd data på RS-485 sidan.





# Inställningar MD-63D



## Val av vändtid/ Överföringshastighet

	Vänd- tid	Överförings- hastighet
SI 	0,4 ms	≤ 2 400 bit/s
SI 	0,2 ms	4 800 bit/s
SI 	0,1 ms	9 600 bit/s
SI 	75 μs	14 400 bit/s
SI 	50 μs	19 200 bit/s
SI 	37 μs	28 800 bit/s
SI 	25 μs	38 400 bit/s
SI 	17 μs	57 600 bit/s
SI 	11 μs	93 750 bit/s
SI 	9 μs	115,2 kbit/s
SI 	6 μs	187,5 kbit/s
SI 	3 μs	375 kbit/s
SI 	2 μs	500 kbit/s
SI 	1 μs	1–1,5 Mbit/s

## Val av antal bitar

SI 	9
SI 	10
SI 	11
SI 	*

\*) Använd denna inställning för synkrona protokoll. Sändaren är aktiv fr o m första databiten till 10 bittider efter den sista höga databiten (se exempel nedan). Hastigheten ställs till  $\approx 10$  ggr den önskade kommunikationshastigheten.

### Exempel 19 200 bit/s

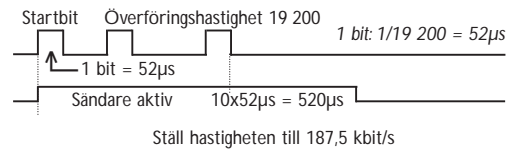

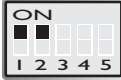

### Val av terminering med fail-safe

S2  Ingen terminering

S2  Terminering

### Val av uteffekt

S2  Låg

S2  Hög

*Fail-safe funktionen tvingar mottagarsignalen till inaktivt läge då den anslutna sändaren är i tri-state (inaktiv).*

### Val av termineringsmotstånd

S2  Terminering kabeltyp A (220Ω)

S2  Terminering kabeltyp B (150Ω)

### Fabriksinställning

S1 

S2 

Se kabeltyper sid. 6

## Anslutningar MD-63D

MD-63D används mot utrustning med RS-485 gränssnitt. Anslutning görs till den 9-poliga D-sub kontakten eller till den 9-poliga skruvplinten.

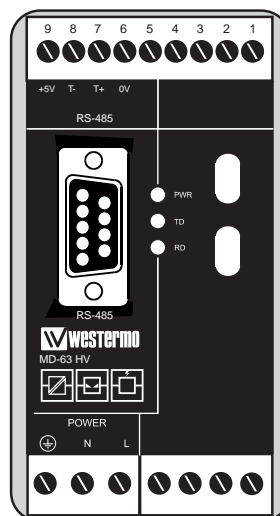

## Linjeanslutning

### Anslutningar

Benämning	9-polig D-sub	9-polig skruvplint	Beskrivning
T- (B)	3	8	Linjeanslutning
T+ (A)	8	7	Linjeanslutning
+5 V	6	9	+5V matning
0 V	5	6	Signal jord

Definitionen T+/T- kan variera mellan olika tillverkare.

### Kabeltyper

Benämning	Impedans	Kapacitans	Resistans	Ledararea
Kabeltyp A	135–165Ω (3–20MHz)	<30pF/m	<110Ω/km	≥0,34 mm <sup>2</sup> (22AWG)
Kabeltyp B	100–130Ω (>100kHz)	<60pF7m	–	≥0,22 mm <sup>2</sup> (24AWG)

### Anslutningsexempel

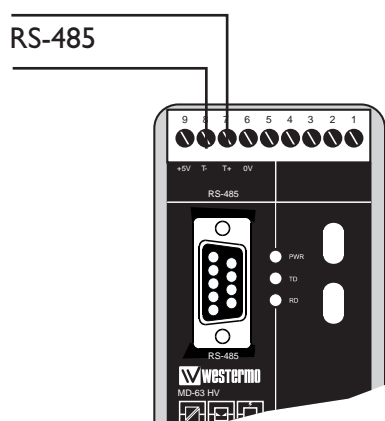

Anslutning till skruvplint

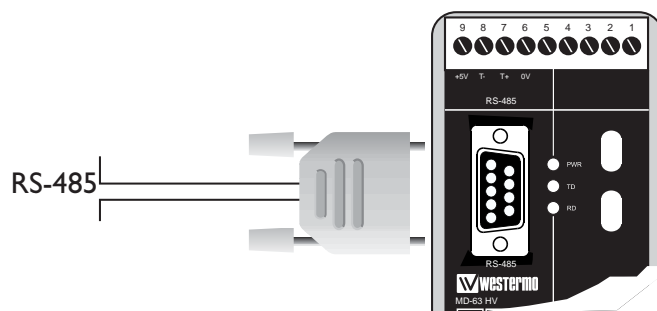

Anslutning till 9-polig D-sub

# Fiberoptisk anslutning

## Anslutningsexempel

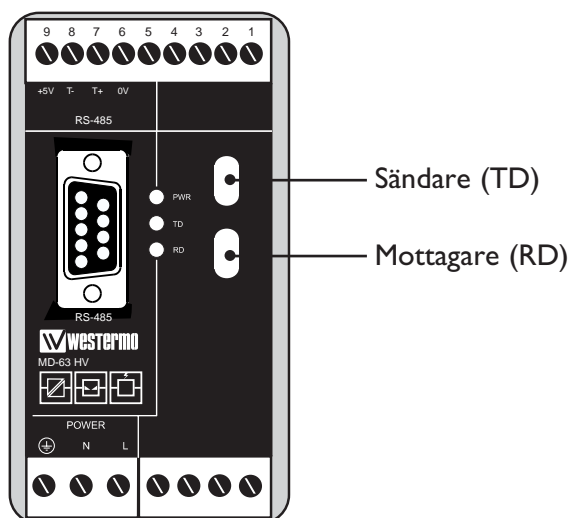
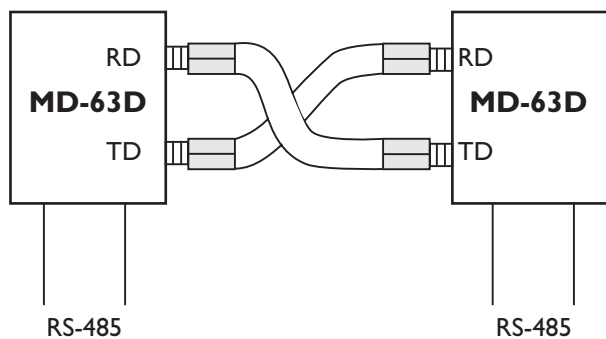

# Matningsanslutning

## Anslutning MD-63D LV

### 2-polig skruvplint

Anslutning	Spänningsanslutning
1	- Lågspänning
2	+ Lågspänning

## Anslutning MD-63D HV

### 3-polig skruvplint

Anslutning	Spänningsanslutning
L	- Högspänning
N	+ Högspänning
O	Skyddsjord

# Effektbudget

## Min. budget



Enhet			
Fiber	820 nm	1300 nm	singelmod
50/125	10,7 dB	8,1 dB	
62,5/125	14,5 dB	11,6 dB	
100/140	20,6 dB		
9/125			6,3 dB

## Typ. budget



Enhet			
Fiber	820 nm	1300 nm	singelmod
50/125	16,6 dB	14,6 dB	
62,5/125	18,6 dB	15,1 dB	
100/140	25,9 dB		
9/125			12,3 dB

”Min. budget” anger garanterat minsta effektbudget. Erfarenheten visar dock att värdet oftast ligger i nivå med angivet ”Typ. budget”.

## Förluster i fiberoptisk kabel

Nedan angivna värden kan variera beroende på kvalitet och fabrikat på den fiberoptiska kabeln.

Fiber	Dämpning vid 820 nm	Dämpning vid 1300 nm	Dämpning vid singelmod (1300 nm)
50/125 $\mu\text{m}$	3,0 dB/km	1,0 dB/km	
62,5/125 $\mu\text{m}$	3,5 dB/km	1,2 dB/km	
100/140 $\mu\text{m}$	4,0 dB/km		
9/125 $\mu\text{m}$			0,5 dB/km

## Förluster i kontakter

0,2–0,4 dB

## Förluster i skarv

Svetsad 0,1 dB

Mekanisk 0,2 dB



## Functional description MD-63D

MD-63D is developed for RS-485 point-to-point communication and conversion between RS-485 and fibre. The unit use standard 9-position D-sub for connection with RS-485. Possibility to connect to a 9-position screw block is also available.

The fibre optic interface uses ST-connectors and both multi mode and single mode fibre versions are available. The maximum transmission distance is calculated from the available power budget of the modems and the attenuation of the cable, splice joints and connectors. Distances up to 25 km can be reached using single mode fibres. The fibre optical cable is completely immune to external interference, which makes it ideal for harsh enviroments.

The modem consists of one F/O channel with separate transmitter and receiver. On the front of the unit there are also three LED's indicating the data transmission on the channel.

MD-63D can be used at all standard transmission speeds up to 1.5 Mbit/s and all operating parameters are set-up via DIP switches easily assessable under the lid on the top of each unit.

MD-63D is available in low (LV) and highvoltage (HV) versions.

MD-63D LV supports power supplies 12–45 V AC  $\pm$  5% and 12–55 V DC  $\pm$  5%.

MD-63D HV supports power supplies 95–240 V AC  $\pm$  5% and 110–240 V DC  $\pm$  5%

## Specifications MD-63D

<b>Transmission</b>	Asynchronous, full/half duplex or simplex
<b>Interface 1</b>	EIA RS-485 / ITU-T V.11 RS-485 9-position D-sub alt. 5-position screw block
<b>Interface 2</b>	Fibre optical 2 ST-connections
<b>Data rate</b>	9.6, 19.2, 93.75, 187.5, 500, 1500kbit/s
<b>Indicators</b>	PWR, TD, RD
<b>Temperature range</b>	5–50°C ambient temperature
<b>Humidity</b>	0–95% RH without condensation
<b>Dimension</b>	55x100x128 mm (WxHxD)
<b>Weight</b>	0.4 kg
<b>Mounting</b>	On 35mm DIN-rail
<b>Power supply alternatives</b>	

Model description	MD-63D HV	MD-63D LV
Power supply	95–240 V AC $\pm$ 10% / 110–240 V DC $\pm$ 10%	12–45 V AC $\pm$ 10% / 12–55 V DC $\pm$ 10%
Frequency	48–62 Hz / –	48–62 Hz / –
Fuse, FI	1 A T / 1 A T Wickmann	1 A T / 1 A T Wickmann
Power consumption	40 mA	3 W
Overvoltage protection	430 V	430 V
Isolation, RMS	3 750 V	3 750 V

## LEDs for indication on MD-63D

- PWR: Indicates that the unit has power
- TD: Indicates received data on RS-485 side.
- RD: Indicates transmitting data on RS-485 side.

# Switch settings MD-63D



## Selection of Turning time/ Transmission rate

SI	Turning time	Transmission rate
SI [ON] 1 2 3 4 5 6 7 8 9	0.4 ms	≤ 2 400 bit/s
SI [ON] 1 2 3 4 5 6 7 8 9	0.2 ms	4 800 bit/s
SI [ON] 1 2 3 4 5 6 7 8 9	0.1 ms	9 600 bit/s
SI [ON] 1 2 3 4 5 6 7 8 9	75 μs	14 400 bit/s
SI [ON] 1 2 3 4 5 6 7 8 9	50 μs	19 200 bit/s
SI [ON] 1 2 3 4 5 6 7 8 9	37 μs	28 800 bit/s
SI [ON] 1 2 3 4 5 6 7 8 9	25 μs	38 400 bit/s
SI [ON] 1 2 3 4 5 6 7 8 9	17 μs	57 600 bit/s
SI [ON] 1 2 3 4 5 6 7 8 9	11 μs	93 750 bit/s
SI [ON] 1 2 3 4 5 6 7 8 9	9 μs	115.2 kbit/s
SI [ON] 1 2 3 4 5 6 7 8 9	6 μs	187.5 kbit/s
SI [ON] 1 2 3 4 5 6 7 8 9	3 μs	375 kbit/s
SI [ON] 1 2 3 4 5 6 7 8 9	2 μs	500 kbit/s
SI [ON] 1 2 3 4 5 6 7 8 9	1 μs	1–1.5 Mbit/s

## Selections of bits

SI [ON] 1 2 3 4 5 6 7 8 9	9
SI [ON] 1 2 3 4 5 6 7 8 9	10
SI [ON] 1 2 3 4 5 6 7 8 9	11
SI [ON] 1 2 3 4 5 6 7 8 9	*

\*) Use this setting for synchronous protocols. The transmitter will be active from the start bit to 10 bit-times after the last high databit (see example below). The speed shall be set to ≈10 times the required communication speed.

### Example 19 200 bit/s

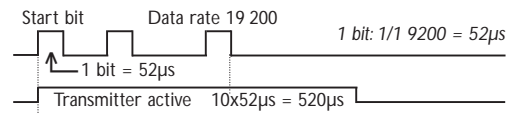

Set the speed to 187.5 kbit/s

### Selection of termination with fail-safe

S2  No termination

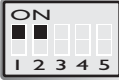
S2  Termination

### Selection of transmitted power

S2  Low

S2  High

The fail-safe function forces the received signal to inactive state when the connected transmitter is in tri-state (transmitter inactive).

### Selection of termination resistor

S2  Termination cable type A (220Ω)

S2  Termination cable type B (150Ω)

### Factory settings

S1 

S2 

See cable types page 14

# Connections MD-63D

MD-63D is developed for RS-485 communication. The connection is made via the 9-position D-sub or the 9-position screw block.

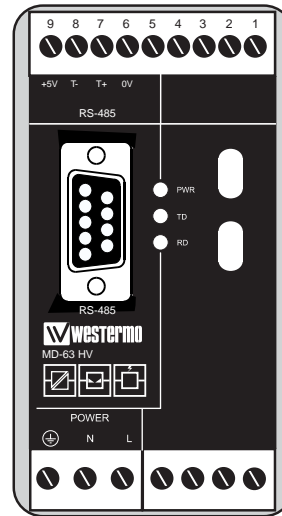

## Line connection

### Connections

Designation	9-pos D-sub	9-pos screw block	Description
T- (B)	3	8	Line connection
T+ (A)	8	7	Line connection
VP	6	9	+5V supply
DGND	5	6	Signal ground

The definitions T+/T- can be various between different manufactures.

### Cable types

Designation	Impedance	Capacity	Resistance	Conductor area
Cable type A	135–165Ω (3–20MHz)	<30pF/m	<110Ω/km	≥0,34 mm <sup>2</sup> (22AWG)
Cable type B	100–130Ω (>100kHz)	<60pF7m	–	≥0,22 mm <sup>2</sup> (24AWG)

### Connection example

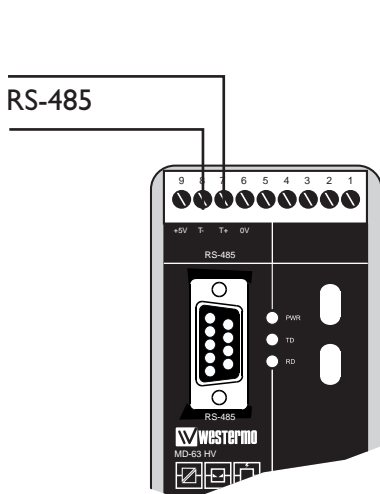

Connection to screw block

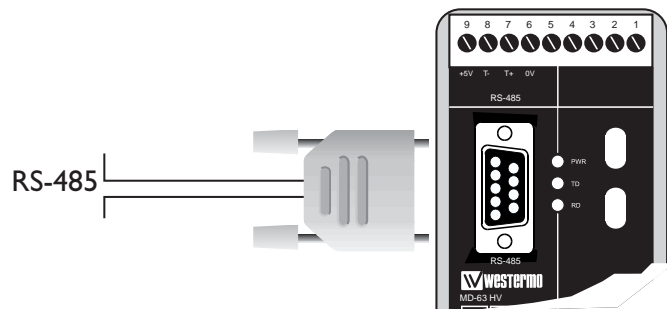

Connection to 9-pos D-sub

# Fibre optical connection

## Connection example

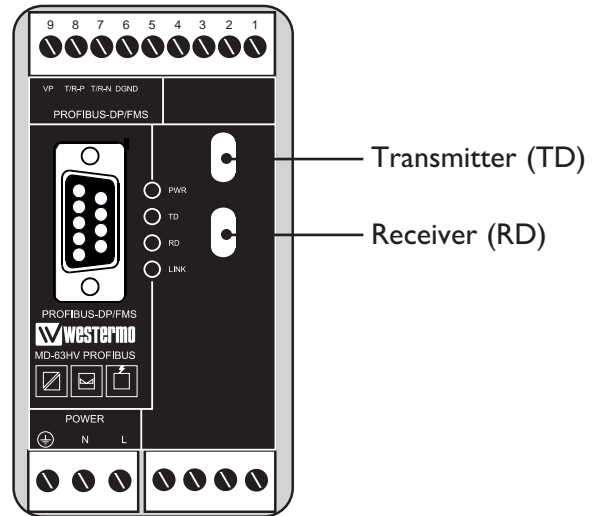
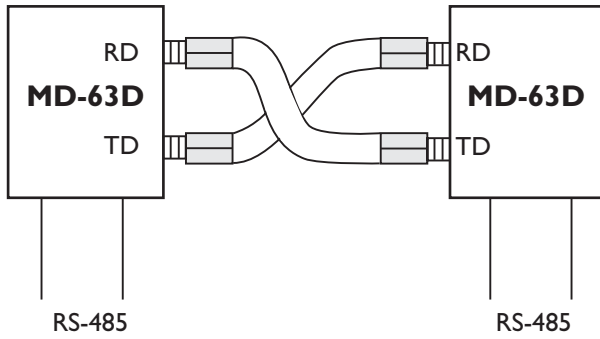

# Power connections

## Connection MD-63LV

### 2-position screw-terminal

Screw no.	Power supply
1	- Low voltage
2	+ Low voltage

## Connection MD-63HV

### 3-position screw-terminal

Connection	Power supply
L	- High voltage
N	+ High voltage
O	Protective earth

# Power budget

## Min. budget



Unit			
Fibre	820 nm	1300 nm	single mode
50/125	10.7 dB	8.1 dB	
62.5/125	14.5 dB	11.6 dB	
100/140	20.6 dB		
9/125			6.3 dB

## Typ. budget



Unit			
Fibre	820 nm	1300 nm	single mode
50/125	16.6 dB	14.6 dB	
62.5/125	18.6 dB	15.1 dB	
100/140	25.9 dB		
9/125			12.3 dB

”Min. budget” states the minimum guaranteed power budget. Experience shows however that the typical value is in the range of the indicated ”Typ. budget”.

## Attenuation in fibre cable

The values below can differ depending on quality and manufacturer of the fibre-optic cable.

Fibre	Attenuation at 820 nm	Attenuation at 1300 nm	Attenuation at single mode (1300 nm)
50/125 µm	3.0 dB/km	1.0 dB/km	
62.5/125 µm	3.5 dB/km	1.2 dB/km	
100/140 µm	4.0 dB/km		
9/125 µm			0.5 dB/km

## Attenuation in connectors

0.2–0.4 dB

## Attenuation in splice

Fusion 0.1 dB

Mechanical 0.2 dB



## Funktionsbeschreibung MD-63D

Der MD-63D ermöglicht die Wandlung zwischen RS-485 und Glasfaser. Der Leitungsteiler wurde speziell für den Einsatz mit RS-485 Multidropssystemen entwickelt und besitzt einen 9-poligen Sub-D für den RS-485 Anschluss. Jedoch kann auch eine 9-polige Schraubklemme als RS-485 Anschluss benutzt werden.

Die Glasfaserschnittstellen sind als ST Typen ausgeführt und können als Multimode und Singlemode Versionen geliefert werden. Die maximale Übertragungsweite errechnet sich aus der zulässigen Dämpfung des Modems und der Summe der einzelnen Dämpfungen der Fasern, Splice und Verbindern. Es können Übertragungsweiten von bis zu 25 Km, mit Singlemode, erzielt werden.

Das MD-63 hat einen Glasfaser Kanal, mit separater Sende- und Empfangseinheit. Auf der Frontplatte sind drei LED's zur Überwachung der Datenübertragung angebracht. Das MD-63D kann bei allen Standard Übertragungsgeschwindigkeiten bis zu 1,5 Mbit/s eingesetzt werden. Alle Einstellungen werden über DIP-Schalter getätigt, die sich leicht zugänglich unter der oberen Abdeckung befinden.

Das MD-63D ist in Niedrig-(LV) und Hochspannungsversionen (HV) erhältlich. Das MD-63LV ist für Betriebsspannungen von 12–45 V AC  $\pm 5\%$  und 12–55 V DC  $\pm 5\%$ . MD-63HV ist für Spannungen von 95–240 V AC  $\pm 5\%$  und 110–240 V DC  $\pm 5\%$ .

## Technische Daten MD-63D

<b>Übertragungsarten</b>	Asynchron, Voll-/Halbduplex oder Simplex
<b>Schnittstelle 1</b>	EIA RS-485 / ITU-T V.11 9-pol. Sub-D oder 9-pol. Schraubklemme
	5 polige Schraubklemme
<b>Schnittstelle 2</b>	2 ST-Glasfaseranschlüsse
<b>Übertragungsraten</b>	bis zu 1.5 Mbit
<b>Leuchtdioden</b>	PWR, TD, RD, LINK
<b>Temperaturbereich</b>	5–50°C
<b>Luftfeuchtigkeit</b>	0–95%, nicht kondensierend
<b>Abmessungen</b>	55x100x128 mm (BxHxT)
<b>Gewicht</b>	0,4 kg
<b>Installation</b>	auf 35 mm DIN-Hutschiene

### Spannungsversorgungs Alternativen

Model Beschreibung	MD-63HV	MD-63LV
Spannungsversorgung	95–240V AC $\pm$ 10% / 110–240V DC $\pm$ 10%	12–45V AC $\pm$ 10% / 12–55V DC $\pm$ 10%
Frequenz	48–62Hz / –	48–62Hz / –
Sicherung, FI	1A T / 1A T Wickmann	1A T / 1A T Wickmann
Leistungsaufnahme	40 mA	3W
Überspannungsschutz	430V	430V
Isolationsspannung	3 750V	3 750V

## Leuchtdioden des MD-63D

- PWR: Das Gerät hat Versorgungsspannung
- TD: Datenempfang auf der RS-485 Seite
- RD: Datensendung auf der RS-485 Seite

# DIP-Schalter Einstellung MD-63D

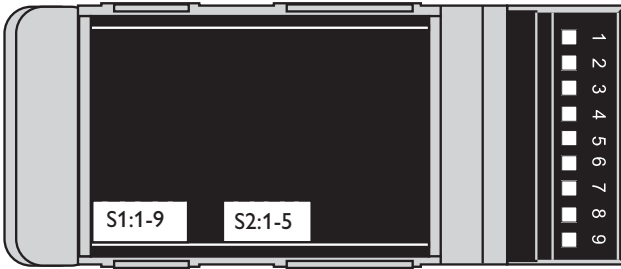

## Umschaltzeit/Übertragungsrate Anzahl der in Serie schaltbaren Geräte

	Umschaltzeit	Übertragungsrate
SI	0,4 ms	≤ 2 400 bit/s
SI	0,2 ms	4 800 bit/s
SI	0,1 ms	9 600 bit/s
SI	75 μs	14 400 bit/s
SI	50 μs	19 200 bit/s
SI	37 μs	28 800 bit/s
SI	25 μs	38 400 bit/s
SI	17 μs	57 600 bit/s
SI	11 μs	93 750 bit/s
SI	9 μs	115,2 kbit/s
SI	6 μs	187,5 kbit/s
SI	3 μs	375 kbit/s
SI	2 μs	500 kbit/s
SI	1 μs	1–1,5 Mbit/s

## Anzahl der Bits

SI	ON	9
SI	ON	10
SI	ON	11
SI	ON	*

\*) Benutzen Sie diese Einstellung für synchrone Protokolle.  
Der Sender ist aktiv ab dem Startbit. Nach dem letzten Hilit bleibt er noch für 10 Bit Zeit aktiv (siehe Beispiel). Die Geschwindigkeit sollte etwa 10 mal höher der benötigten Geschwindigkeit gesetzt werden.

## Beispiel 19 200 Bit/s

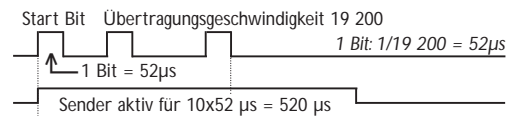



# Zulässige Dämpfung

## Min. Werte



Einheit			
Faser	820 nm	1300 nm	Mono-mode
50/125	10,7 dB	8,1 dB	
62,5/125	14,5 dB	11,6 dB	
100/140	20,6 dB		
9/125			6,3 dB

## Typ. Werte



Einheit			
Faser	820 nm	1300 nm	Mono-mode
50/125	16,6 dB	14,6 dB	
62,5/125	18,6 dB	15,1 dB	
100/140	25,9 dB		
9/125			12,3 dB

“min Werte” sind die maximal zulässigen Dämpfungen. Die Erfahrung hat jedoch gezeigt, daß die “Typ. Werte” eher zutreffen.

## Dämpfungen in Glasfaserkabeln

Die genannten Werte können von Qualität und Hersteller des Glasfaserkabels variieren.

Faser	Dämpfung bei 820 nm	Dämpfung bei 1300 nm	Dämpfung bei Monomode (1300 nm)
50/125 µm	3,0 dB/km	1,0 dB/km	
62,5/125 µm	3,5 dB/km	1,2 dB/km	
100/140 µm	4,0 dB/km		
9/125 µm			0,5 dB/km

## Dämpfung in Verbindern

0,2-0,4 dB

## Spleißdämpfung

geschweißt 0,1 dB

mechanisch 0,2 dB

# Anschlüsse MD-63D

MD-63D wurde für RS-485 Übertragungen entwickelt. Der Anschluss geschieht über einen 9-pol. Sub-D oder eine 9-pol. Schraubklemme.

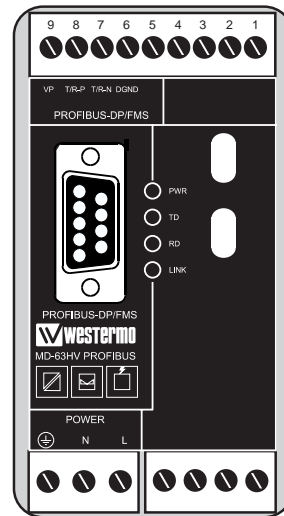

## Leistungsanschluß

### Anschlüsse

Bezeichnung	Pin Nr. 9-pol. Sub-D	Pin Nr. 9-pol Schraubklemme	Beschreibung
T/R-P	3	8	Leistungsanschluss – P
T/R-N	8	7	Leistungsanschluss – N
VP	6	9	+5V Versorgung
DGND	5	6	Signal Ground

### Kabeltypen

Bezeichnung	Impedanz	Kapazität	Widerstand	Querschnitt
Kabeltyp A	135–165Ω (3–20MHz)	<30pF/m	<110Ω/km	≥0,34 mm <sup>2</sup> (22AWG)
Kabeltyp B	100–130Ω (>100kHz)	<60pF7m	–	≥0,22 mm <sup>2</sup> (24AWG)

### Anschlussbeispiel

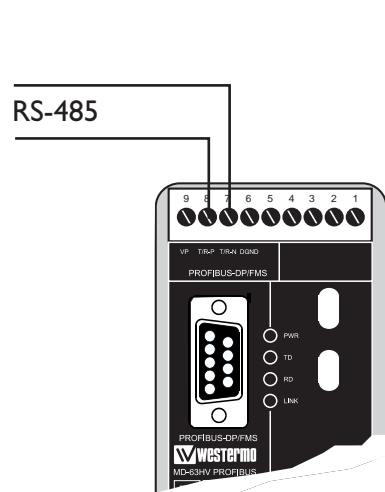

Anschluss an Schraubklemme

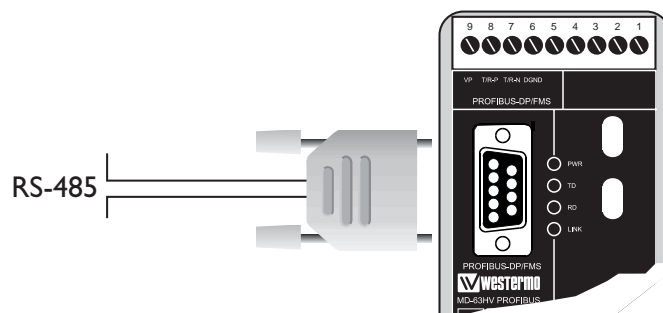

Anschluss an 9-pol. Sub-D

# Glasfaser Anschluss

## Anschlussbeispiel

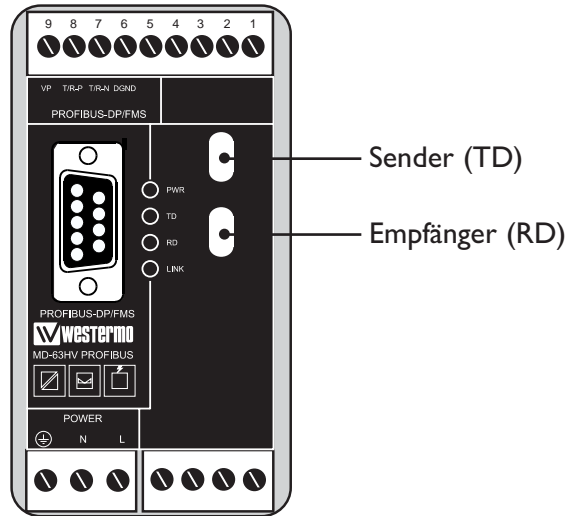
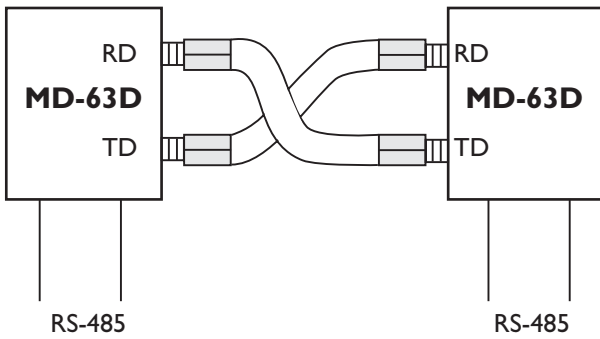

Sender (TD)

Empfänger (RD)

# Spannungsversorgungs Anschluß

## Anschlüsse MD-63LV

### 2-polige Schraubklemme

Klemme Nr.	Spg.-Versorgung
1	- Pol
2	+ Pol

## Anschlüsse MD-63HV

### 3-polige Schraubklemme

Klemme Nr.	Spg.-Versorgung
L	Hochspannung
N	Hochspannung
O	Schutzerde







# Application example

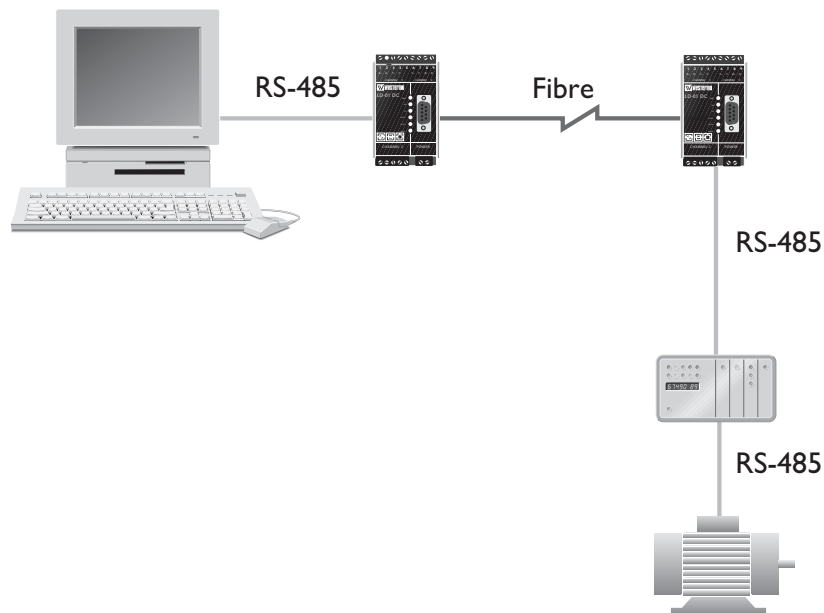

Westermo Teleindustri AB • SE-640 40 Stora Sundby, Sweden

Phone +46 16 42 80 00 Fax +46 16 42 80 01

E-mail: [info@westermo.se](mailto:info@westermo.se)

**Westermo Web site: [www.westermo.com](http://www.westermo.com)**

## Subsidiaries

Westermo OnTime AS  
Gladsvei 20 0489 Oslo, Norway  
Phone +47 220 903 03 • Fax +47 220 903 10  
E-mail: [contact@ontimenet.com](mailto:contact@ontimenet.com)

Westermo Data Communications Ltd  
Talisman Business Centre • Duncan Road  
Park Gate, Southampton • SO31 7GA  
Phone: +44(0)1489 580 585 • Fax: +44(0)1489 580586  
E-Mail: [sales@westermo.co.uk](mailto:sales@westermo.co.uk)

Westermo Data Communications GmbH  
Goethestraße 67, 68753 Waghäusel  
Tel.: +49(0)7254-95400-0 • Fax: +49(0)7254-95400-9  
E-Mail: [info@westermo.de](mailto:info@westermo.de)

Westermo Data Communications S.A.R.L.  
9 Chemin de Chilly 91160 CHAMPLAN  
Tél : +33 1 69 10 21 00 • Fax : +33 1 69 10 21 01  
E-mail : [infos@westermo.fr](mailto:infos@westermo.fr)

*Westermo Teleindustri AB have distributors in several countries, contact us for further information.*